

APT

The Name You Can Trust



2024

HYDRAULIC EQUIPMENT CATALOGUE

The Name You Can Trust



The Name You Can Trust

APT International

About:

With Decades of experience, APT International is a global emerging brand that is determined to lead, with solid experience in Product development, manufacturing, distributing, selling, and servicing world class products. We aspire to become a global brand that is trusted by our customers for our tools, accessories, and equipment.

Believing that to build a great tool you need great materials is the driver of our manufacturing process, and for that we source the absolute best raw materials and components to build the most powerful and efficient tool for our customers to rely on.

We put our customers at the heart of everything we do, and we make sure that our wide range of products is available for them in every market we enter through a strong network of central distribution centers, local distributors, and retailers. Complemented with a vast network of service centers equipped with highly qualified technicians delivering a world class customer service quality to ensure our customers complete satisfaction.

Our Values:

Reliability: Our tools are built to last, for our customers to trust that they will consistently deliver the same quality every time.

Quality: We have a passionate commitment to providing high quality tools that exceed our customers' expectations.

Value for Money: Our advanced production capabilities enable us to offer our customers an unmatched combination of reliability, quality & price.

Innovation: We continuously strive to bring innovative solutions, for our customers to have the tools they need to get the job done.

Customer Focus: Our customers are at the heart of everything we do, we listen to their needs and work to deliver what they desire.

CONTENTS

Hydraulic Equipment

HYDRAULIC BOTTLE JACKS 1

HYDRAULIC BOTTLE JACKS 4-2

HYDRAULIC TROLLEY JACKS 5

HYDRAULIC TROLLEY JACKS 6

HYDRAULIC GARAGE JACKS 7

HYDRAULIC GARAGE JACKS 10-8

JACK STANDS 11

JACK STANDS 11

HYDRAULIC SHOP PRESS 12

HYDRAULIC SHOP PRESS 14-13

TRANSMISSION AND LIFTING 15

transmission and lifting 23-16



HYDRAULIC BOTTLE JACKS



The Name
You Can Trust

HYDRAULIC BOTTLE JACKS

Low Profile Bottle Jack

Environmentally friendly steel plate
Oil leakage preventive system
Prolonged oil lifetime

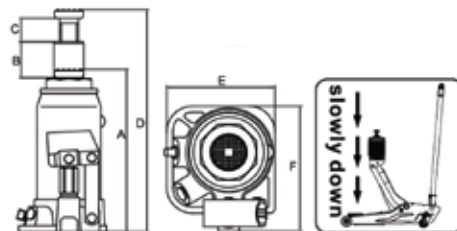

T90204D



T90304D



T90504D



T91004D



T91504D



T92004D

TECHNICAL DATA

Model	Capacity	Min.Height	Lift.Height	Adjustable Height	Pcs/Ctn	A	B	C	D	E×F
	Ton	MM	MM	MM		MM				
T90204D	2	148	80	48	6	140	72	48	260	88×92
T90304D	3	180	110	60	6	168	98	60	326	92×100
T90504D	5	185	110	60	4	185	110	60	355	96×112
T91004D	10	195	120	60	4	195	120	60	375	110×123
T91504D	15	205	125	60	2	205	125	60	390	133×136
T92004D	20	217	130	60	2	217	130	60	407	144×152



Heavy Duty Bottle Jack

Environmentally friendly steel plate
Oil leakage preventive system
Prolonged oil lifetime

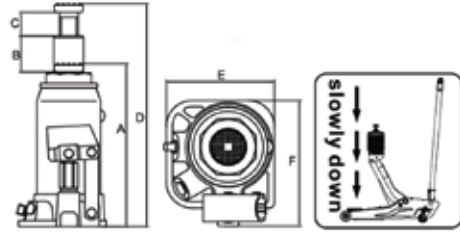

TECHNICAL DATA

Model	Capacity	Min.Height	Lift.Height	Adjustable Height	Pcs/Ctn	A	B	C	D	E×F
	Ton	MM	MM	MM		MM				
T90204	2	181	116	48	6	140	72	48	260	88×92
T90304	3	194	118	60	6	168	98	60	326	92×100
T90504	5	216	127	70	4	185	110	60	355	96×112
T90804	8	230	147	80	4	190	115	60	365	103×118
T91004	10	230	150	80	2	195	120	60	375	110×123
T91504	15	230	150	80	2	205	125	60	390	133×136
T92004	20	242	150	60	2	217	130	60	407	144×152
T93204	32	285	180	/	1	230	130	/	360	130×170
T95004	50	300	180	/	1	217	130	/	370	168×210



HYDRAULIC BOTTLE JACKS

Heavy Duty Welded Bottle Jack

Environmentally friendly steel plate
Oil leakage preventive system
Prolonged oil lifetime

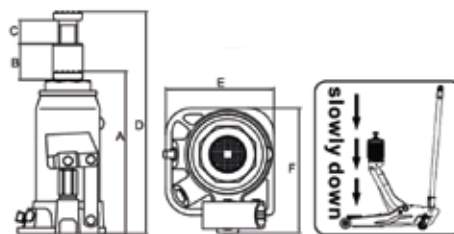

TH93204



TH95004

TECHNICAL DATA

Model	Capacity	Min.Height	Lift.Height	Adjustable Height	Pcs/Ctn	A	B	C	D	E×F
	Ton	MM	MM	MM						
TH93204	32	260	160	/	1	260	160	/	420	185×165
TH95004	50	280	170	/	1	280	170	/	450	207×185





GRIMMSPEED
@3018N

HYDRAULIC TROLLEY JACKS



The Name
You Can Trust

HYDRAULIC TROLLEY JACKS

Trolley Jacks

Special Quality Design

Polished and treated cylinder rams use high performance seals.



Polished inner cylinder walls extending the seals' life minimizing abrasion and wear.



Hydraulic trolley jack is constructed with heavy duty steel, providing long term durability with an industrial luster. Equipped with two large steel casters and two 360-degree swivel casters for smooth maneuverability.



TA82008



TA82007S



TA820050FS



T825010S



TA82001S

TECHNICAL DATA

Model	Capacity	Min.Height	Max.Height	Product Weight	Pcs/Ctn
	Ton	MM	MM	KG	
TA82008	1.5	128	300	6.8	1
TA82007S	2	125	300	6.2	1
TA820050FS	2	135	340	8.5	1
T825010S	2.5	89	359	15.78	1
TA82001S	2	85	330	11.5	1



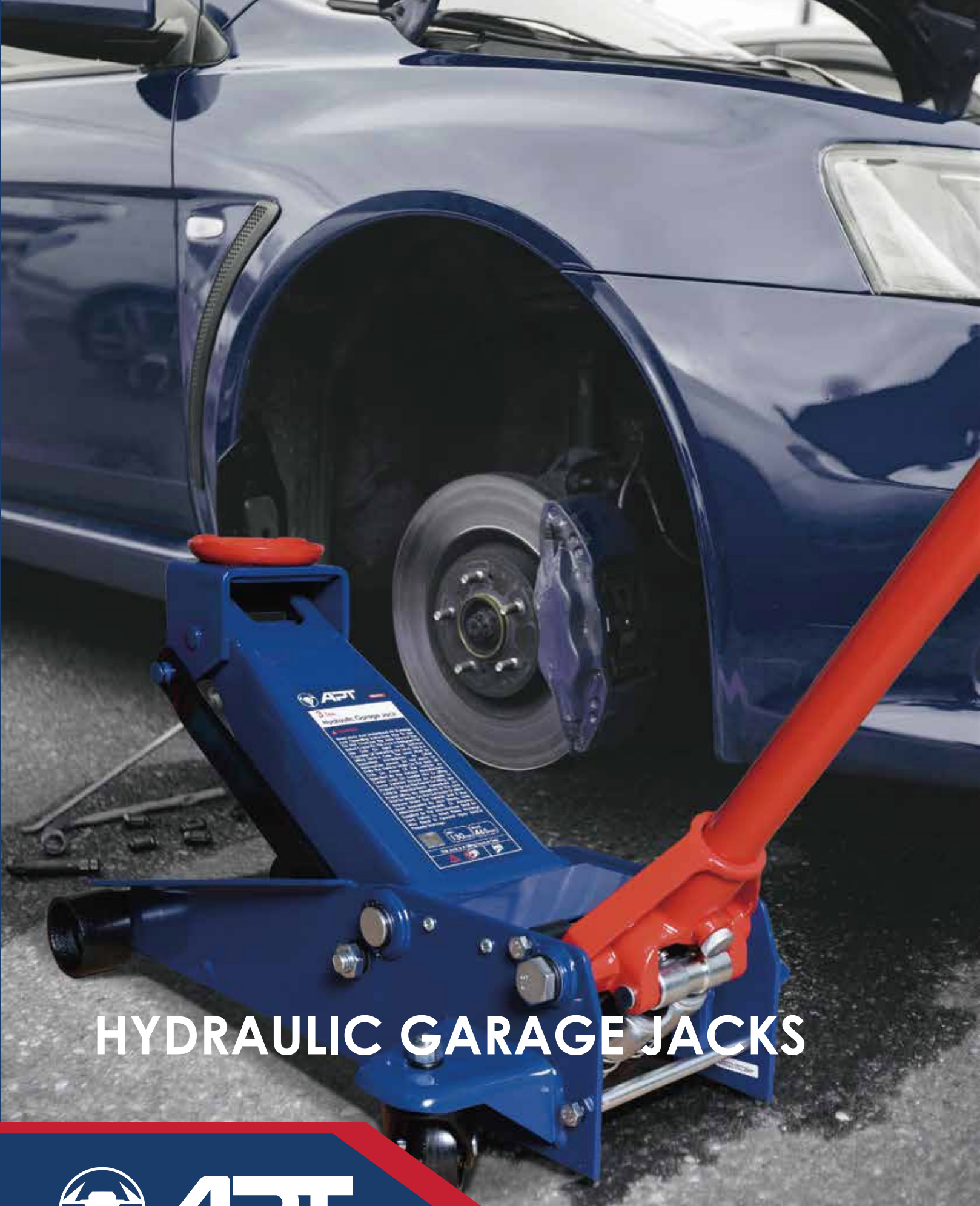

HYDRAULIC GARAGE JACKS



APT

The Name
You Can Trust

HYDRAULIC GARAGE JACKS

Garage Jacks

Constructed of durable, portable heavy duty steel.
 Dual piston quick lift pump allows you to easily raise the jack to the desired height.
 Equipped with two large steel casters and two 360-degree swivel casters for smooth maneuverability.



Special Quality Design

Polished and treated cylinder rams use high performance seals.



Polished inner cylinder walls extending the seals' life minimizing abrasion and wear.



T830022



T830025



T830023



T83502



T830026

TECHNICAL DATA

Model	Capacity	Min.Height	Max.Height	Product Weight	Pcs/Ctn
	Ton	MM	MM	KG	
TZ830022	3	140	500	34.5	1
T830025	3	130	465	29.7	1
T830023	3	130	465	31	1
T83502	3.5	145	500	39	1
T830026	2.5	75	508	36	1





APT

HYDRAULIC GARAGE JACKS

Low Profile Garage Jack

Constructed using heavy duty steel
 Compact
 Protector, top saddle protection for safer lifting.



Slow lowering while loaded



Foot pedal for quick lifting saddle to load



PU Material Front Wheel



Magnetic tools tray for carrying objects



Nylon rear wheel with ball bearing



T820031



T820028



T830028



T830031BS

Polished and treated cylinder rams use high performance seals.



Polished inner cylinder walls extending the seals' life minimizing abrasion and wear.



Polished and treated pump cylinder pistons use high performance seals.



Special Quality Design

TECHNICAL DATA

Model	Capacity	Min.Height	Max.Height	Product Size	Pcs/Ctn
	Ton	MM	MM	MM	
T820031	2	70	500	785x350x212	1
T820028	2	76	510	1065x450x215	1
T830028	3	140	525	1150x350x180	1
T830031BS	3	80	500	822x420x232	1



HYDRAULIC GARAGE JACKS

Long Floor Jacks

Ideal for lifting heavy trucks, buses, agriculture and constructions equipment Heavy duty steel frame for maximum durability.

Long frame for easy access to lift point.

Safety-overload system.

Additional foot pedal control provides quick set-up and rise.

Oversized swivel casters for easy mobility.



TR20003



TR30002



TR50001



TR100001



TRA200001

TECHNICAL DATA

Model	Capacity	Min.Height	Max.Height	Product Size	Pcs/Ctn
	Ton	MM	MM	MM	
TR20003	2	140	800	1184x435x188	1
TR30002	3	140	665	1100x436x186	1
TR50001	5	160	560	1412x418x186	1
TR100001	10	160	560	1540x486x255	1
TRA200001	20	220	680	1550x560x305	1



Jack Stand

Ratchet style allows for fine adjustment and fast removal
 Solid steel handle
 Self-Locking ratchet
 Large saddle
 unitized frame construction
 Ductile iron rack.



T43002



T46002

TECHNICAL DATA

Model	Capacity	Min.Height	Max.Height	N.W./G.W.	Package Size	Pcs/Ctn
	Ton	MM	MM	KG	MM	PAIRS
T43002	3	285	425	6.3/6.78	216x190x355	1
T46002	6	393	593	13/13.8	305x255x460	1



HYDRAULIC SHOP PRESS



The Name
You Can Trust

Electrically Powered Shop Press

Heavy-duty H-frames are made of high-grade steel designed for quality and durability.
Painted to resist oil, grease and stains for easy cleanup.

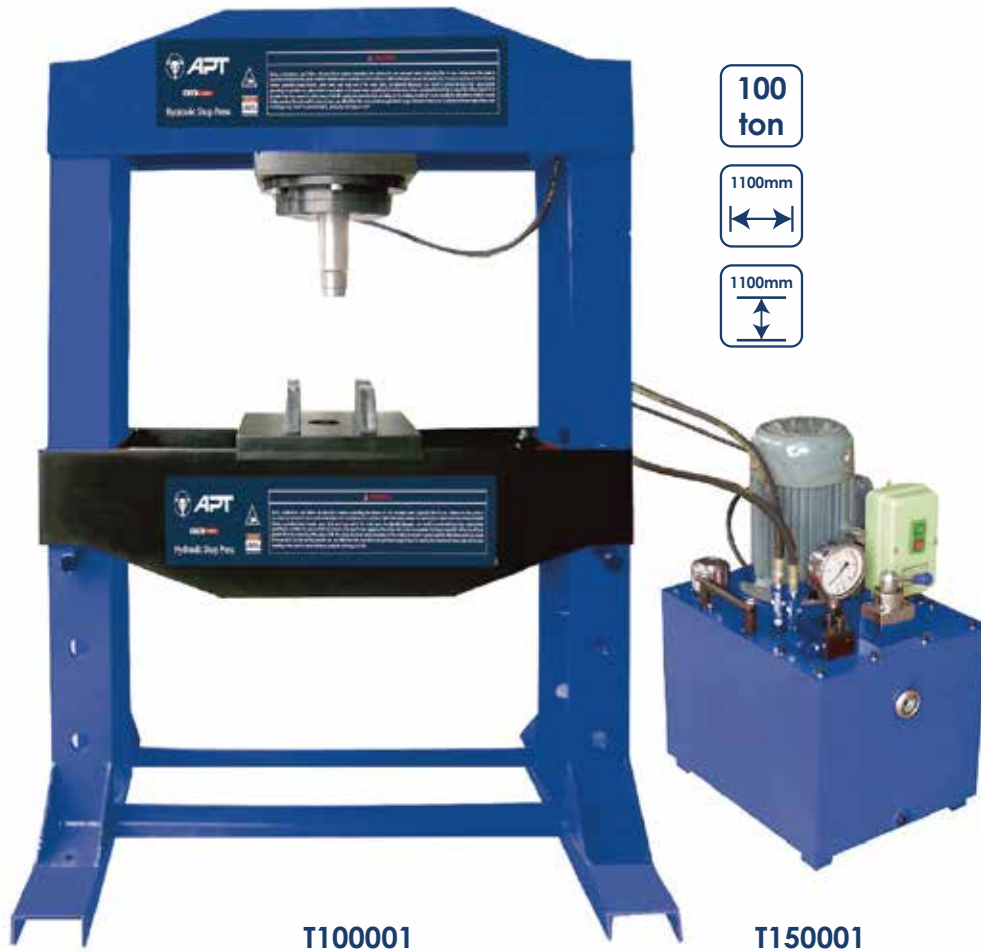

TECHNICAL DATA

Model	Capacity	Work Range	N.W.	G.W.	Package Size	Pcs/Ctn
	Ton	MM	MM	MM	MM	
T100001	100	0-950	740	790	1140x620x2100	1
T150001	150	0-950	1300	1350	1470x2270x650	1

HYDRAULIC SHOP PRESS

Hydraulic Shop Press

Heavy-duty H-frames are made of high-grade steel designed for quality and durability.

Painted to resist oil, grease and stains for easy cleanup.

High-quality, large-diameter hydraulic steel cylinder units result in lower oil pressure Required to increase loads, helping to minimize wear and prolong service life.

10
ton
680mm
175mm



TY10003

12
ton
780mm
175mm



TY12002

20
ton
760mm
175mm



TY20001

30
ton
850mm
150mm



TY30001

50
ton
1200mm
175mm



TY50001



TECHNICAL DATA

Model	Capacity	Work Range	N.W.	G.W.	Package Size	Pcs/Ctn
	Ton	MM	KGS	KGS	MM	
TY10003	10	0-340	46.5	48	775x550x180	1
TY12002	12	0-920	14	15	675x230x170	2
TY20001	20	0-910	36	37	640x320x130	2
TY30001	30	0-970	150	163	1620x380x310	1
TY50001	50	0-890	256	286	930x390x1860	1





TRANSMISSION AND LIFTING



APT

The Name
You Can Trust

TRANSMISSION AND LIFTING

Portable Body Repair Kits

Applications:

- Automotive
- Trucks
- Farm Equipment
- Heavy Equipment

Instructions of use:

- The load can not exceed half of the capacity when all tubes are used
- Piston extension can not exceed the stroke



T70401S



T71002L

TECHNICAL DATA

Model	Capacity	Min. Ram Height	Ram Lifting Height	Package Size	Pcs/Ctn
	Ton	MM	MM	MM	
T70401S	4	270	120	585x355x175	1
T71002L	10	380	150	990x440x220	1





Heavy Duty Vehicle Support Stand

The base is a heavy, durable, flat support platform with increased width for direct load support.

The best choice for heavy vehicles and loads, ensuring load stability and safe handling.



TZ200012



TZ250002

TECHNICAL DATA

Model	Capacity	Min.Height	Max.Height	N.W./G.W.	Product Size	Pcs/Ctn
	Ton	MM	MM	KG	MM	
TZ200012	20	665	1090	39/41.5	460x460x683	1
TZ250002	25	680	968	38.5/41	460x460x698	1



TRANSMISSION AND LIFTING

Engine Crane

Equipped with a precise drain valve to facilitate the positioning of the suspended element.

Compact, fully folds for easy storage

Equipped with 6 metal wheels – and a special handle for easy maneuvering.



1
ton

T31002CX



2
ton

T32002X



2
ton

T32002CX



Foldable

TECHNICAL DATA

Model	Capacity	Lenght	Width	Height	Lifting Range	Pcs/Ctn
	Ton	MM	MM	MM	MM	
T31002CX	1	1515	1015	1445	75-1950	1
T32002X	2	1710	1000	1490	25-2140	2
T32002CX	2	1710	1000	1490	25-2240	2



Piston for Engine Crane

High quality large diameter hydraulic steel cylinder unit results in lower oil pressure needed to raise the load, helping to reduce wear and extend service life.

Constructed of high-grade steel and built for quality and durability.

Hydraulics are powered with a high quality oil, which offers better corrosion resistance and high/low temperature flexibility.



WELDED



T30506

TECHNICAL DATA

Model	Capacity	Min.Height	Max.Height	N.W./G.W.	Package Size	Pcs/Ctn
	Ton	MM	MM	MM	MM	
T30506	2	00	00	00	00	2
T30806	2	00	00	00	00	2

TRANSMISSION AND LIFTING

Transmission Jack

The Low Profile Transmission jack for is designed for transmission installation and removal. It features a 360° handle that offers rotational mobility for hard-to-reach lifting points. Universal mounting head provides a wide fore and aft tilt range. Manual operated hydraulic system, bypass system prevents over-extension and accidental overloading. Low profile design is enhanced by four heavy duty swivel casters for easy maneuvering throughout the shop. Fits most transmissions.



TE10001



Safety Valve



TEL05004



Stronger Steel Base

TEL15011

TECHNICAL DATA

Model	Capacity	Min.Height	Max.Height	Product Size	Pcs/Ctn
	Ton	MM	MM	MM	
TEL05004	0.5	1140	1945	1080x280x145	1
TE10001	1	210	780	965x530x240	1
TEL15011	1.5	1130	1915	1175x320x260	1



Engine Stand

Rotating engine stand is constructed with heavy-duty steel, providing long term durability with an industrial luster.
An extra-wide base provides maximum stability



Foldable



T26801

SPECIFICATIONES

Model	Capacity	N.W.	G.W.	Product Size	Pcs/Ctn
	LBS	KGS	KGS	MM	
T26801	1500	33.5	35.3	870x820x860	1



Hydraulic Pipe Bender

Can bend pipes up to 90 using precision cast dies
6 cast dies included
Suitable for bending gas, water sprinkler and exhaust pipes
Cast dies sizes: 1/2" , 3/4" , 1 , 1 1/4" , 1 1/2" , 2"



TRM03003-3

TECHNICAL DATA

Model	Capacity	N.W.	G.W.	Product Size	Pcs/Ctn
	ton	KGS	KGS	MM	
TRM03003-3	16	67	72	770x360x235	1



TRANSMISSION AND LIFTING

Lifting Table Cart

Lift and lower heavy cargo for smooth, easy loading and unloading.

Ideal for transporting machinery and big tool chests, unloading trucks and more.

Foot-pedal operates the hydraulic tabletop.

Handle-mounted pressure release.



TP05001

TECHNICAL DATA

Model	Capacity	Lifting Range	Platform Size	Package Size	Pcs/Ctn
	ton	MM	MM	MM	
TP05001	0.5	280-860	815x500	950x555x285	1



Enging Leveler

Made of high quality steel, the balancer ensures excellent durability and a long service life.

A crank handle on the end of the leveler makes adjustment easier.



TR2750

TECHNICAL DATA

Model	Capacity	N.W./G.W.	Package Size	Pcs/Ctn
	KGS	KGS/KGS	MM	
TR2750	680	5.2/5.5	480x280x220	4



Plastic Car Creeper

Features a powder-coated finish for added durability.

Comfortable seat has thick foam padding and oil-resistant vinyl covering with built-in padded headrest for cushioned support and lasting comfort.

Swivel casters provide superior mobility.



TRH6802

TECHNICAL DATA

Model	Capacity	N.W.	G.W.	Overall Size	Pcs/Ctn
	LBS	KGS	KGS	MM	
TRH6802	250	5	6	1010x475x130	1



Air Jack

The jack is the easiest and fastest way to lift the car. It inflates with compressed air.

Sturdy Construction The pneumatic jack is made of high strength steel which makes the whole body sturdy and durable. The solid construction also provides lateral and vertical stability.



TRA1812

TECHNICAL DATA

Model	Capacity	Min.Height	Max.Height	Lifting Time	Pcs/Ctn
	Ton	MM	MM	SEC	
TRA1812	2	115	430	3	1



Check Our Range

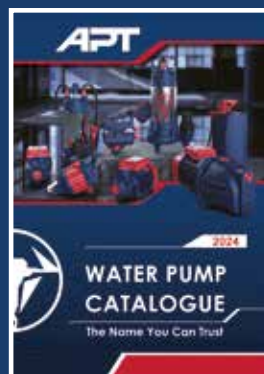

APT

The Name You Can Trust



APT

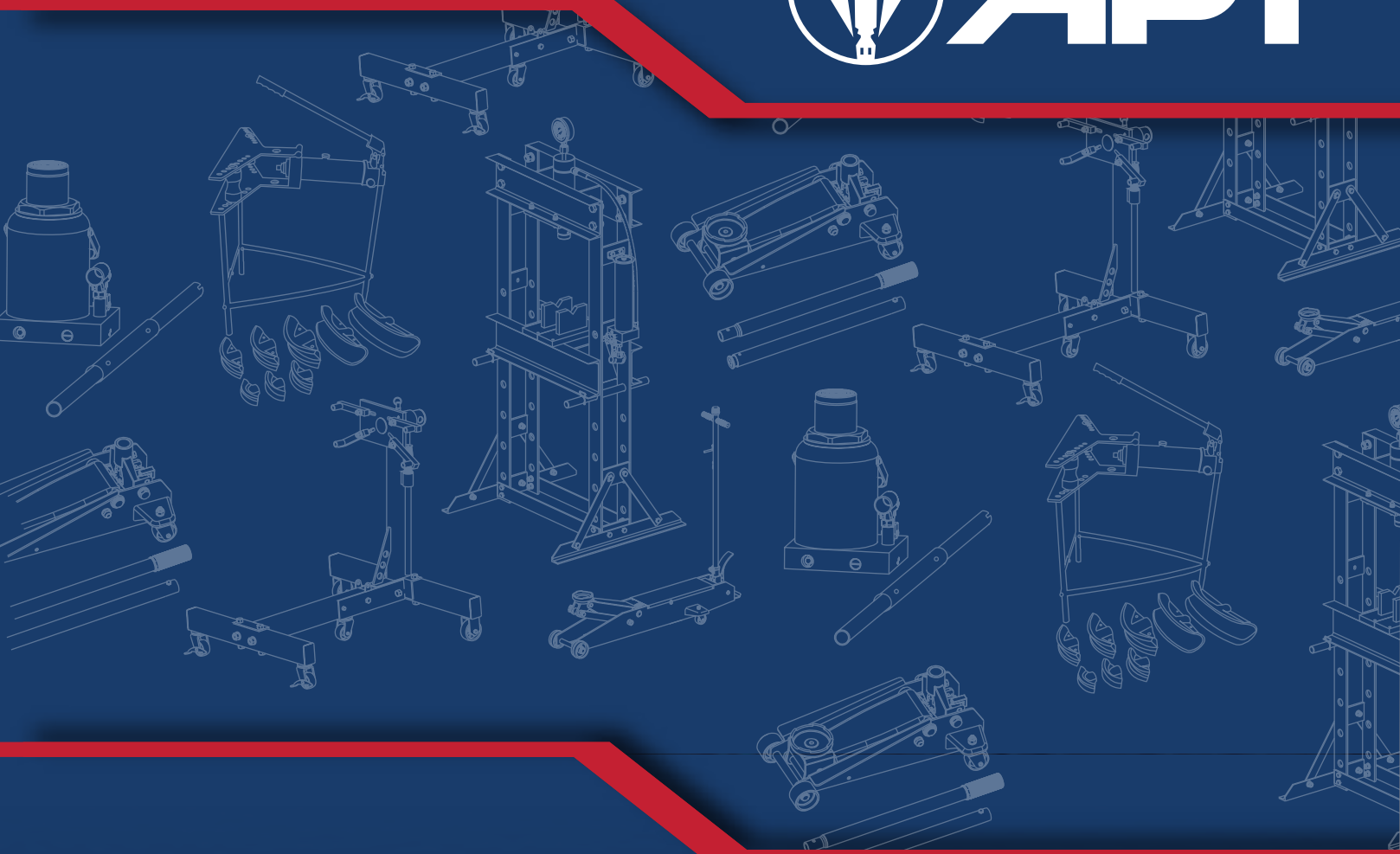

Contact Us



Info@apt-international.com

