

APT



2024

ACCESSORIES CATALOGUE

The Name You Can Trust



APT International

About:

With Decades of experience, APT International is a global emerging brand that is determined to lead, with solid experience in Product development, manufacturing, distributing, selling, and servicing world class products. We aspire to become a global brand that is trusted by our customers for our tools, accessories, and equipment.

Believing that to build a great tool you need great materials is the driver of our manufacturing process, and for that we source the absolute best raw materials and components to build the most powerful and efficient tool for our customers to rely on.

We put our customers at the heart of everything we do, and we make sure that our wide range of products is available for them in every market we enter through a strong network of central distribution centers, local distributors, and retailers. Complemented with a vast network of service centers equipped with highly qualified technicians delivering a world class customer service quality to ensure our customers complete satisfaction.

Our Values:

Reliability: Our tools are built to last, for our customers to trust that they will consistently deliver the same quality every time.

Quality: We have a passionate commitment to providing high quality tools that exceed our customers' expectations.

Value for Money: Our advanced production capabilities enable us to offer our customers an unmatched combination of reliability, quality & price.

Innovation: We continuously strive to bring innovative solutions, for our customers to have the tools they need to get the job done.

Customer Focus: Our customers are at the heart of everything we do, we listen to their needs and work to deliver what they desire.

The Name You Can Trust

CONTENTS

HAMMER DRILL BITS	2-8
HOLLOW DRILL BIT	9
CHISELS	10-12
HSS DRILL BITS	13-18
WOOD DRILL BITS	19
HOLE SAWS	20-22
CUTTING DISCS	23-25
GRINDING DISCS	26-27
CUT-OFF DISCS	28
FIBRE SANDING DISCS	29-30
VELCRO SANDING DISCS	31-33
FLAP DISCS	34-37
DIAMOND SAW BLADE	38
DIAMOND CORE BITS	39-40
DIAMOND SAW BLADE	41-48
WELDING CONSUMABLES	49
JIG SAW BLADE	50-55
TILE SCORING WHEEL	56
SCREWDRIVER BITS & ACCESSORIES	57-61

SDS-Plus Drill Bit

Applications



Concrete



Stone



Brick



Breeze Block



CARBIDE:
135° tip angle,
10% lifetime increased



FLUTES:
Double flutes
Fast dust removal



SHANK:
Compatible SDS-PLUS shank



SDS-Plus Drill Bit

TECHNICAL DATA

		DIAMETER (mm)	TOTAL LENGTH (mm)
9600104110	LCA02040110	4	110
9600105110	LCA02050110	5	110
9600106110	LCA02060110	6	110
9600106160	LCA02060160	6	160
9600106210	LCA02060210	6	210
9600107160	LCA02070160	7	160
9600108110	LCA02080110	8	110
9600108160	LCA02080160	8	160
9600108210	LCA02080210	8	210
9600108260	LCA02080260	8	260
9600108450	LCA02080450	8	450
9600109160	LCA02090160	9	160
9600110110	LCA02100110	10	110
9600110160	LCA02100160	10	160
9600110210	LCA02100210	10	210
9600110260	LCA02100260	10	260
9600110310	LCA02100310	10	310
9600110350	LCA02100350	10	350
9600110400	LCA02100400	10	400
9600111160	LCA02110160	11	160
9600112160	LCA02120160	12	160
9600112210	LCA02120210	12	210
9600112260	LCA02120260	12	260
9600112310	LCA02120310	12	310
9600112350	LCA02120350	12	350
9600112400	LCA02120400	12	400
9600112450	LCA02120450	12	450
9600112800	LCA02120800	12	800
9600112999	LCA02121000	12	1000
9600114160	LCA02140160	14	160
9600114210	LCA02140210	14	210
9600114260	LCA02140260	14	260
9600114310	LCA02140310	14	310
9600114350	LCA02140350	14	350
9600114400	LCA02140400	14	400
9600114450	LCA02140450	14	450
9600114600	LCA02140600	14	600
9600114800	LCA02140800	14	800
9600114999	LCA02141000	14	1000
9600116210	LCA02160210	16	210
9600116260	LCA02160260	16	260
9600116310	LCA02160310	16	310
9600116350	LCA02160350	16	350

		DIAMETER (mm)	TOTAL LENGTH (mm)
9600116400	LCA02160400	16	400
9600116450	LCA02160450	16	450
9600116600	LCA02160600	16	600
9600116800	LCA02160800	16	800
9600118210	LCA02180210	18	210
9600118260	LCA02180260	18	260
9600118310	LCA02180310	18	310
9600118350	LCA02180350	18	350
9600118400	LCA02180400	18	400
9600118450	LCA02180450	18	450
9600118800	LCA02180800	18	800
9600118999	LCA02181000	18	1000
9600120210	LCA02200210	20	210
9600120260	LCA02200260	20	260
9600120310	LCA02200310	20	310
9600120350	LCA02200350	20	350
9600120400	LCA02200400	20	400
9600120450	LCA02200450	20	450
9600120600	LCA02200600	20	600
9600120800	LCA02200800	20	800
9600120999	LCA02201000	20	1000
9600122260	LCA02220260	22	0260
9600122350	LCA02220350	22	350
9600122400	LCA02220400	22	400
9600122450	LCA02220450	22	450
9600122600	LCA02220600	22	600
9600122800	LCA02220800	22	800
9600122999	LCA02221000	22	1000
9600124260	LCA02240260	24	260
9600124350	LCA02240350	24	350
9600124400	LCA02240400	24	400
9600124450	LCA02240450	24	450
9600124600	LCA02240600	24	600
9600125260	LCA02250260	25	260
9600125350	LCA02250350	25	350
9600125450	LCA02250450	25	450
9600125600	LCA02250600	25	600
9600126260	LCA02260260	26	260
9600126350	LCA02260350	26	350
9600126600	LCA02260600	26	600
9600126800	LCA02260800	26	800
9600126999	LCA02261000	26	1000

SDS-Plus W Head



CARBIDE:
Self centring tip
for easy positioning



FLUTES:
Effective dust removal



SHANK:
Compatible SDS-PLUS shank



Applications



Concrete



Stone



Brick



Breeze Block

TECHNICAL DATA

Barcode	Part Number	DIAMETER (mm)	TOTAL LENGTH (mm)
9600414340	LCA10140340	14	340
9600414540	LCA10140540	14	540
9600416400	LCA10160400	16	400
9600416600	LCA10160600	16	600
9600418390	LCA10180390	18	390
9600418540	LCA10180540	18	540
9600420370	LCA10200370	20	370
9600420520	LCA10200520	20	520
9600422370	LCA10220370	22	370
9600422520	LCA10220520	22	520
9600425370	LCA10250370	25	370
9600425520	LCA10250520	25	520
9600428370	LCA10280370	28	370
9600428570	LCA10280570	28	570
9600430370	LCA10300370	30	370
9600430570	LCA10300570	30	570
9600432370	LCA10320370	32	370
9600435370	LCA10350370	35	370
9600438370	LCA10380370	38	370
9600438570	LCA10380570	38	570
9600440370	LCA10400370	40	70
9600440570	LCA10400570	40	570

SDS-Plus 4 Cutting Edges

Applications



Concrete



Stone



Brick



Breeze Block



CARBIDE:
Tings tip drill round hole
and better performance



FLUTES:
dust removal



SHANK:
Patible SDS-PLUS shank



SDS-Plus 4 Cutting Edges

TECHNICAL DATA

		DIAMETER (mm)	TOTAL LENGTH (mm)
9600306110	LCA04060110	6	110
9600306160	LCA04060160	6	160
9600308160	LCA04080160	8	160
9600308210	LCA04080210	8	210
9600308260	LCA04080260	8	260
9600308450	LCA04080450	8	450
9600310160	LCA04100160	10	160
9600310210	LCA04100210	10	210
9600310310	LCA04100310	10	310
9600310350	LCA04100350	10	350
9600310400	LCA04100400	10	400
9600314160	LCA04140160	14	160
9600314210	LCA04140210	14	210
9600314260	LCA04140260	14	260
9600314350	LCA04140350	14	350
9600314450	LCA04140450	14	450
9600314999	LCA04140999	14	999
9600316210	LCA04160210	16	210
9600316310	LCA04160310	16	310
9600316350	LCA04160350	16	350
9600316450	LCA04160450	16	450
9600316600	LCA04160600	16	600
9600316999	LCA04160999	16	999
9600318210	LCA04180210	18	210
9600318260	LCA04180260	18	260
9600318310	LCA04180310	18	310
9600318350	LCA04180350	18	350

		DIAMETER (mm)	TOTAL LENGTH (mm)
9600318400	LCA04180400	18	400
9600318450	LCA04180450	18	450
9600318600	LCA04180600	18	600
9600318800	LCA04180800	18	800
9600318999	LCA04180999	18	1000
9600320210	LCA04200210	20	210
9600320260	LCA04200260	20	260
9600320400	LCA04200400	20	400
9600320450	LCA04200450	20	450
9600320800	LCA04200800	20	800
9600322260	LCA04220260	22	260
9600322350	LCA04220350	22	350
9600322400	LCA04220400	22	400
9600324260	LCA04240260	24	260
9600324350	LCA04240350	24	350
9600324400	LCA04240400	24	400
9600324600	LCA04240600	24	600
9600325350	LCA04250350	25	350
9600326260	LCA04260260	26	260
9600326600	LCA04260600	26	600
9600326800	LCA04260800	26	800
9600326999	LCA04260999	26	1000
9600312210	LCA04120210	12	210
9600312310	LCA04120310	12	310
9600312400	LCA04120400	12	400
9600312999	LCA04120999	12	1000

SDS- Max Hammer Drill Bits 2



CARBIDE:
135° tip angle,
10% lifetime increased

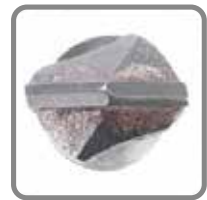

FLUTES:
Double flutes
Fast dust removal



SHANK:
Compatible SDS-MAX shank



Applications



Concrete



Stone



Brick



Breeze Block

TECHNICAL DATA

Barcode	Part Number	DIAMETER (mm)	TOTAL LENGTH (mm)
9600402237	LCA27220370	22	370
9600402257	LCA27220570	22	570
9600402280	LCA27220800	22	800
9600402537	LCA27250370	25	370
9600402557	LCA27250570	25	570
9600402837	LCA27280370	28	370
9600402857	LCA27280570	28	570
9600403257	LCA27320570	32	570

SDS-Max Hammer Drill Bits



CARBIDE:
4 cutters tip performances
round holes
4 cuttings tip



FLUTES:
Fast dust removal



SHANK:
Compatible SDS-max shank



Applications



Concrete



Stone



Brick



Breeze Block

TECHNICAL DATA

		DIAMETER (mm)	TOTAL LENGTH (mm)
9600212160	LCA03120160	12	160
9600214160	LCA03140160	14	160
9600214210	LCA03140210	14	210
9600216210	LCA03160210	16	210
9600216260	LCA03160260	16	260
9600216400	LCA03160400	16	400
9600218210	LCA03180210	18	210
9600218310	LCA03180310	18	310
9600220260	LCA03200260	20	260
9600222260	LCA03220260	22	260
9600224600	LCA03240600	24	600
9600225260	LCA03250260	25	260
9600226260	LCA03260260	26	260
9600226600	LCA03260600	26	600

Hollow Drill Bit

TECHNICAL DATA

		DIAMETER (mm)	No. of carbide tips	TOTAL LENGTH (mm)
-	LCH01030	30	4T	70
-	LCH01035	35	4T	70
-	LCH01040	40	5T	70
-	LCH01045	45	5T	70
-	LCH01050	50	6T	70
-	LCH01055	55	6T	70
-	LCH01060	60	7T	70
-	LCH01065	65	8T	70
-	LCH01070	70	8T	70
-	LCH01075	75	8T	70
-	LCH01080	80	10T	70
-	LCH01090	90	11T	70
-	LCH01100	100	12T	70
-	LCH01150	150	14T	70



Adaptor





TECHNICAL DATA

		SPECIFICATION	LENGTH (mm)
-	LC-C0300110	SDS-Plus	110
-	LC-C0300250	SDS-Plus	250
-	LC-C0300400	SDS-Plus	400
-	LC-C0300600	SDS-Plus	600
-	LC-C0400400	SDS-Max	400
-	LC-C0400600	SDS-Max	600

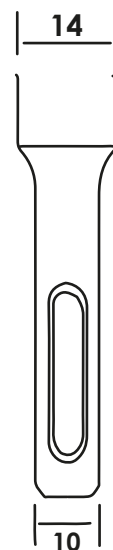
SDS-Plus Chisel



TECHNICAL DATA

		SPECIFICATION	DIAMETER (mm)	TOTAL LENGTH (mm)
9600131425	LCC01.00250	Point	14	250
9600141430	LCC01.00300	Point	14	300
9600141440	LCC01.00400	Point	14	400
9600151425	LCC01.20250	Flat	14	250x20
9600151430	LCC01.20300	Flat	14	300x20
9600151450	LCC01.50250	Flat	14	250x50
9600151009	LCC42.10150	Flat Alloy	10	150x9.1
9600151210	LCC42.12150	Flat Alloy	12	150x10.4
9600151411	LCC42.14150	Flat Alloy	14	150x11.9

SDS-Max Chisel

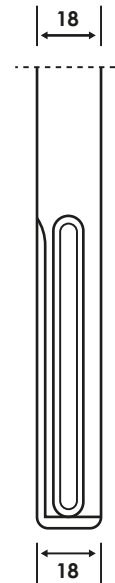

TECHNICAL DATA

		SPECIFICATION	DIAMETER (mm)	TOTAL LENGTH (mm)
9600181840	LCC02.00400	Point	18	400
9600181860	LCC02.00600	Point	18	600
9600184025	LCC02.25400	Flat	18	400x25
9600184050	LCC02.50400	Flat	18	400x50
9600186025	LCC02.25600	Flat	18	600x25

HEX Chisel



TECHNICAL DATA

		SPECIFICATION	DIAMETER (mm)	TOTAL LENGTH (mm)
9600191725	LCC03.25280	Flat	17	280x25
9600191726	LCC03.40280	Wide	17	280x40
9600191727	LCC03.25400	Flat	17	400x25
9600191728	LCC03.00280	Point	17	280
9600191740	LCC03.00400	Point	17	400
9600191960	LCC03.25280	Gouge	17	280x25

Hex Chisel Type 28



TECHNICAL DATA

		SPECIFICATION	DIAMETER (mm)	TOTAL LENGTH (mm)
9600186285	LCC07.00400	Point	28	400
9600186286	LCC07.75400	Flat	28	400x75
9600204028	LCC10.00400	Point	28	400
9600204328	LCC10.35400	Flat	28	400x35
9600204528	LCC10.75400	Flat	28	400x75

PH65 Chisel 60Si2Mn Steel

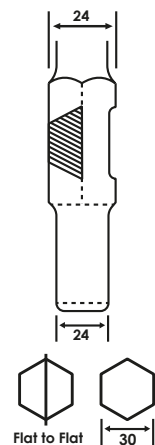

TECHNICAL DATA

		SPECIFICATION	DIAMETER (mm)	TOTAL LENGTH (mm)
9600186550		Point	30	400
9600186560		Flat	30	400x30

HSS straight shank twist drill bits, fully ground M35

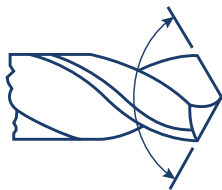

Split-point angle 135°











Self-centering



Features:

- Self-centering
- Wide split-point angle for efficient drilling
- Covers a wide range of base materials
- Cost efficient
- Improved lifetime
- Reduces effort and labor fatigue

Applications:

			
Bronze	Brass	Copper	Alloy steel
			
Tubes steel and shaped	Sheet metal	Non-ferrous metal	Aluminum

TECHNICAL DATA

		DIAMETER (mm)	TOTAL LENGTH (mm)
6221257032703	9640020100	1	34
6221257032710	9640020150	1.5	43
6221257032727	9640020180	1.8	46
6221257032734	9640020200	2	49
6221257032741	9640020220	2.2	53
6221257032758	9640020230	2.3	53
6221257032765	9640020240	2.4	57
6221257032772	9640020250	2.5	57
6221257032789	9640020300	3	61
6221257032796	9640020310	3.1	65
6221257032802	9640020320	3.2	65
6221257032819	9640020330	3.3	65
6221257032826	9640020340	3.4	70
6221257032833	9640020350	3.5	70
6221257032840	9640020360	3.6	70
6221257032857	9640020370	3.7	70
6221257032864	9640020380	3.8	75
6221257032871	9640020390	3.9	75
6221257032888	9640020400	4	75
6221257032895	9640020410	4.1	75
6221257032901	9640020420	4.2	75
6221257032918	9640020450	4.5	80
6221257032925	9640020460	4.6	80
6221257032932	9640020480	4.8	86
6221257032949	9640020500	5	86
6221257032956	9640020520	5.2	86
6221257032963	9640020550	5.5	93
6221257032970	9640020580	5.8	93
6221257032987	9640020600	6	93
6221257032994	9640020650	6.5	101
6221257033007	9640020700	7	109
6221257033014	9640020750	7.5	109
6221257033021	9640020800	8	117
6221257033038	9640020850	8.5	117
6221257033045	9640020900	9	125
6221257033052	9640020950	9.5	125
6221257033069	9640021000	10	133
6221257033076	9640021050	10.5	133
6221257033083	9640021100	11	142
6221257033090	9640021150	11.5	142
6221257033106	9640021200	12	151
6221257033113	9640021250	12.5	151
6221257033120	9640021300	13	151
6221257033137	9640021350	13.5	160
6221257033144	9640021400	14	160
6221257033151	9640021450	14.5	169
6221257033168	9640021500	15	169
6221257033175	9640021550	15.5	178
6221257033182	9640021600	16	178
6221257033199	9640021650	16.5	184
6221257033205	9640021700	17	184
6221257033212	9640021750	17.5	191
6221257033229	9640021800	18	191
6221257033236	9640021900	19	198
6221257033243	9640022000	20	205

HSS straight shank twist drill bits, fully ground bright finish

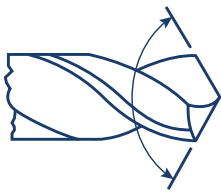

Split-point angle 135°



Self-centering

Features:

- Self-centering
- Wide split-point angle for efficient drilling
- Covers a wide range of base materials
- Cost efficient
- Improved lifetime
- Reduces effort and labor fatigue
- Inceased productivity

Applications:



Bronze



Brass



Copper



Alloy steel



Tubes steel and shaped



Sheet metal





Cu, Ni, Ms, Zn

Non-ferrous metal



Aluminum

TECHNICAL DATA

		DIAMETER (mm)	TOTAL LENGTH (mm)
6221257031133	9640000035	0.35	19
6221257031140	9640000040	0.40	20
6221257031157	9640000045	0.45	20
6221257031164	9640000050	0.50	22
6221257031171	9640000055	0.55	24
6221257031188	9640000060	0.60	24
6221257031195	9640000065	0.65	26
6221257031201	9640000070	0.70	28
6221257031218	9640000075	0.75	28
6221257031225	9640000080	0.80	30
6221257031232	9640000085	0.85	32
6221257031249	9640000090	0.90	32
6221257031256	9640000095	0.95	34
6221257031263	9640000100	1.00	34
6221257031270	9640000105	1.05	36
6221257031287	9640000110	1.10	36
6221257031294	9640000115	1.15	38
6221257031300	9640000120	1.20	38
6221257031317	9640000125	1.25	38
6221257031324	9640000130	1.30	40
6221257031331	9640000135	1.35	40
6221257031348	9640000140	1.40	40
6221257031355	9640000145	1.45	40
6221257031362	9640000150	1.50	43
6221257031379	9640000155	1.55	43
6221257031386	9640000160	1.60	43
6221257031393	9640000165	1.65	43
6221257031409	9640000170	1.70	46
6221257031416	9640000175	1.75	46
6221257031423	9640000180	1.80	46
6221257031430	9640000190	1.90	46
6221257031447	9640000200	2.00	49
6221257031454	9640000210	2.10	49
6221257031461	9640000220	2.20	53
6221257031478	9640000230	2.30	53
6221257031485	9640000240	2.40	57
6221257031492	9640000250	2.50	57
6221257031508	9640000260	2.60	57
6221257031515	9640000270	2.70	61
6221257031522	9640000280	2.80	61
6221257031539	9640000290	2.90	61
6221257031546	9640000300	3.00	61
6221257031553	9640000310	3.10	65
6221257031560	9640000320	3.20	65
6221257031577	9640000330	3.30	65
6221257031584	9640000340	3.40	70
6221257031591	9640000350	3.50	70
6221257031607	9640000360	3.60	70
6221257031614	9640000370	3.70	70
6221257031621	9640000380	3.80	75

HSS straight shank twist drill bits, fully ground bright finish

TECHNICAL DATA

		DIAMETER (mm)	TOTAL LENGTH (mm)
6221257031638	9640000390	3.90	75
6221257031645	9640000400	4.00	75
6221257031652	9640000410	4.10	75
6221257031669	9640000420	4.20	75
6221257031676	9640000430	4.30	80
6221257031683	9640000440	4.40	80
6221257031690	9640000450	4.50	80
6221257031706	9640000460	4.60	80
6221257031713	9640000470	4.70	80
6221257031720	9640000480	4.80	86
6221257031737	9640000490	4.90	86
6221257031744	9640000500	5.00	86
6221257031751	9640000510	5.10	86
6221257031768	9640000520	5.20	86
6221257031775	9640000530	5.30	86
6221257031782	9640000540	5.40	93
6221257031799	9640000550	5.50	93
6221257031805	9640000560	5.60	93
6221257031812	9640000570	5.70	93
6221257031829	9640000580	5.80	93
6221257031836	9640000590	5.90	93
6221257031843	9640000600	6.00	93
6221257031850	9640000610	6.10	101
6221257031867	9640000620	6.20	101
6221257031874	9640000630	6.30	101
6221257031881	9640000640	6.40	101
6221257031898	9640000650	6.50	101
6221257031904	9640000660	6.60	101
6221257031911	9640000670	6.70	101
6221257031928	9640000680	6.80	109
6221257031935	9640000690	6.90	109
6221257031942	9640000700	7.00	109
6221257031959	9640000710	7.10	109
6221257031966	9640000720	7.20	109
6221257031973	9640000730	7.30	109
6221257031980	9640000740	7.40	109
6221257031997	9640000750	7.50	109
6221257032000	9640000760	7.60	117
6221257032017	9640000770	7.70	117
6221257032024	9640000780	7.80	117
6221257032031	9640000790	7.90	117

		DIAMETER (mm)	TOTAL LENGTH (mm)
6221257032048	9640000800	8.00	117
6221257032055	9640000810	8.10	117
6221257032062	9640000820	8.20	117
6221257032079	9640000830	8.30	117
6221257032086	9640000840	8.40	117
6221257032093	9640000850	8.50	117
6221257032109	9640000860	8.60	125
6221257032116	9640000870	8.70	125
6221257032123	9640000880	8.80	125
6221257032130	9640000890	8.90	125
6221257032147	9640000900	9.00	125
6221257032154	9640000910	9.10	125
6221257032161	9640000920	9.20	125
6221257032178	9640000930	9.30	125
6221257032185	9640000940	9.40	125
6221257032192	9640000950	9.50	125
6221257032208	9640000980	9.80	133
6221257032215	9640000990	9.90	133
6221257032222	9640001000	10.00	133
6221257032239	9640001050	10.50	133
6221257032246	9640001100	11.00	142
6221257032253	9640001150	11.50	142
6221257032260	9640001200	12.00	151
6221257032277	9640001250	12.50	151
6221257032284	9640001300	13.00	151
6221257032291	9640001350	13.50	160
6221257032307	9640001400	14.00	160
6221257032314	9640001450	14.50	169
6221257032321	9640001500	15.00	169
6221257032338	9640001550	15.50	178
6221257032345	9640001600	16.00	178
6221257032352	9640001650	16.50	184
6221257032369	9640001700	17.00	184
6221257032376	9640001750	17.50	191
6221257032383	9640001800	18.00	191
6221257032390	9640001850	18.50	198
6221257032406	9640001900	19.00	198
6221257032413	9640001950	19.50	205
6221257032420	9640002000	20.00	205
6221257032437	9640002200	22.00	205

HSS straight shank twist drill bits, fully ground Black&Bronze

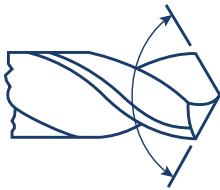

Split-point angle 135°



Self-centering

Features:

- Self-centering
- Wide split-point angle for efficient drilling
- Covers a wide range of base materials
- Cost efficient
- Improved lifetime
- Reduces effort and labor fatigue
- Inceased productivity
- Works in harder materials

Applications:



Bronze



Brass



Copper



Alloy steel



Tubes steel and shaped



Sheet metal



Cu, Ni, Ms, Zn

Non-ferrous metal



Aluminum

TECHNICAL DATA

Barcode	Key	DIAMETER (mm)	TOTAL LENGTH (mm)
6221257033649	9640040100	1	34
6221257033656	9640040150	1.5	43
6221257033663	9640040200	2	49
6221257033670	9640040250	2.5	57
6221257033687	9640040300	3	61
6221257033694	9640040320	3.2	65
6221257033700	9640040350	3.5	70
6221257033717	9640040400	4	75
6221257033724	9640040450	4.5	80
6221257033731	9640040500	5	86
6221257033748	9640040550	5.5	93
6221257033755	9640040600	6	93
6221257033762	9640040650	6.5	101
6221257033779	9640040700	7	109
6221257033786	9640040750	7.5	109
6221257033793	9640040800	8	117
6221257033809	9640040850	8.5	117
6221257033816	9640040900	9	125
6221257033823	9640040950	9.5	125
6221257033830	9640041000	10	133
6221257033847	9640041050	10.5	133
6221257033854	9640041100	11	142
6221257033861	9640041150	11.5	142
6221257033878	9640041200	12	151
6221257033885	9640041250	12.5	151
6221257033892	9640041300	13	151
6221257033908	9640041350	13.5	160
6221257033915	9640041400	14	160
6221257033922	9640041450	14.5	169
6221257033939	9640041500	15	169
6221257033946	9640041550	15.5	178
6221257033953	9640041600	16	178
6221257033960	9640041650	16.5	184
6221257033977	9640041700	17	184
6221257033984	9640041750	17.5	191
6221257033991	9640041800	18	191
6221257034004	9640041900	19	198
6221257034011	9640042000	20	205

HSS straight shank twist drill bits, fully ground titanium-coated

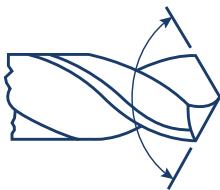

Split-point angle 135°



Self-centering

Features:

- Self-centering
- Wide split-point angle for efficient drilling
- Covers a wide range of base materials
- Cost efficient
- Improved lifetime
- Reduces effort and labor fatigue
- Increased productivity
- Works in harder materials

Applications:

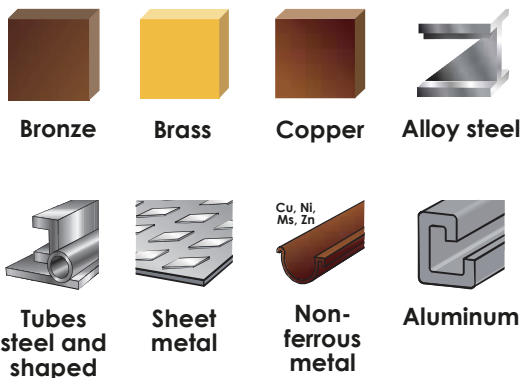

TECHNICAL DATA

		DIAMETER (mm)	TOTAL LENGTH (mm)
6221257033274	9640030100	1	34
6221257033281	9640030150	1.5	43
6221257033298	9640030200	2	49
6221257033304	9640030250	2.5	57
6221257033311	9640030300	3	61
6221257033328	9640030350	3.5	70
6221257033335	9640030400	4	75
6221257033342	9640030450	4.5	80
6221257033359	9640030500	5	86
6221257033366	9640030550	5.5	93
6221257033373	9640030600	6	93
6221257033380	9640030650	6.5	101
6221257033397	9640030700	7	109
6221257033403	9640030750	7.5	109
6221257033410	9640030800	8	117
6221257033427	9640030850	8.5	117
6221257033434	9640030900	9	125
6221257033441	9640030950	9.5	125
6221257033458	9640031000	10	133
6221257033465	9640031050	10.5	133
6221257033472	9640031100	11	142
6221257033489	9640031150	11.5	142
6221257033496	9640031200	12	151
6221257033502	9640031250	12.5	151
6221257033519	9640031300	13	151
6221257033526	9640031350	13.5	160
6221257033533	9640031400	14	160
6221257033540	9640031450	14.5	169
6221257033557	9640031500	15	169
6221257033564	9640031550	15.5	178
6221257033571	9640031600	16	178
6221257033588	9640031650	16.5	184
6221257033595	9640031700	17	184
6221257033601	9640031750	17.5	191
6221257033618	9640031800	18	191
6221257033625	9640031900	19	198
6221257033632	9640032000	20	205

Taper shank drill bits, milled, black



Split-point angle 135°



Self-centering

Features:

- Self-centering
- Wide split-point angle for efficient drilling
- Covers a wide range of base materials
- Cost efficient
- Improved lifetime
- Reduces effort and labor fatigue

Applications:

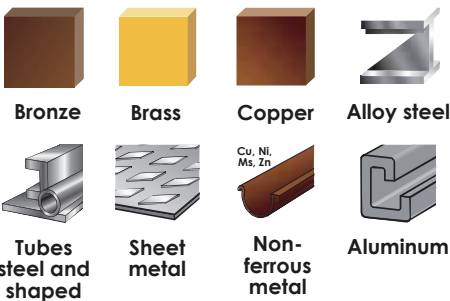

TECHNICAL DATA

Barcode	Key	DIAMETER (mm)	TOTAL LENGTH (mm)
6221257032499	9640011500	15	212
6221257032505	9640011550	15.5	218
6221257032512	9640011600	16	218
6221257032529	9640011650	16.5	223
6221257032536	9640011700	17	223
6221257032543	9640011750	17.5	228
6221257032550	9640011800	18	228
6221257032567	9640011850	18.5	233
6221257032574	9640011900	19	233
6221257032581	9640011950	19.5	238
6221257032598	9640012000	20	238
6221257032604	9640012050	20.5	243
6221257032611	9640012100	21	243
6221257032628	9640012200	22	248
6221257032635	9640012300	23	253
6221257032642	9640012400	24	281
6221257032659	9640012500	25	281
6221257032666	9640012600	26	286
6221257032673	9640012700	27	291
6221257032680	9640013000	30	296
6221257032697	9640013200	32	296

HSS Step Drill Straight Flute



TECHNICAL DATA

Barcode	SPECIFICATION	DIAMETER (mm)	TOTAL LENGTH (mm)
9640092412	Tin Coated	4-12	280x25
9640092425	Tin Coated	4-25	280x40
9640092432	Tin Coated	4-32	400x25
9640094425	Cobalt Coated	4-25	280
9640094432	Cobalt Coated	4-32	400

Flat Wood Drill Three Point



Features:

- Fast drilling
- Clean drilling
- Covers a wide range of hard and soft woods
- Applications include pipe/electric clearance holes

Applications:

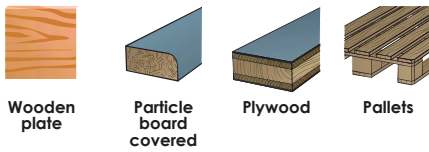

TECHNICAL DATA

		DIAMETER (mm)	TOTAL LENGTH (mm)
6221257034028	9640060006	06	155
6221257034035	9640060008	08	155
6221257034042	9640060010	10	155
6221257034059	9640060012	12	155
6221257034066	9640060014	14	155
6221257034073	9640060016	16	155
6221257034080	9640060018	18	155
6221257034097	9640060020	20	155
6221257034103	9640060022	22	155
6221257034110	9640060024	24	155
6221257034127	9640060025	25	155
6221257034134	9640060028	28	155
6221257034141	9640060030	30	155
6221257034158	9640060032	32	155
6221257034165	9640060035	35	155
6221257034172	9640060038	38	155
6221257034189	9640060042	42	155

Three Point Wood Drill Roll Forged And Polished



Features:

- Rapid drilling of deep holes
- Covers a wide range of hard, soft woods, plywood and chipboard
- Applications include boring through beams, joists, doors, etc.

Applications:

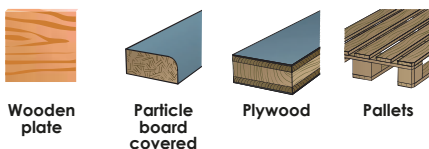

TECHNICAL DATA

		DIAMETER (mm)	TOTAL LENGTH (mm)
6221257034196	9640070003	3	61
6221257034202	9640070004	4	75
6221257034219	9640070005	5	86
6221257034226	9640070006	6	93
6221257034233	9640070007	7	109
6221257034240	9640070008	8	117
6221257034257	9640070010	10	133
6221257034264	9640070012	12	151
6221257034271	9640070013	13	151
6221257034288	9640070014	14	
6221257034295	9640070015	15	
6221257034301	9640070016	16	
6221257034318	9640070018	18	
6221257034325	9640070019	19	
6221257034332	9640070020	20	

TCT Hole Saw for Metal - Carbide

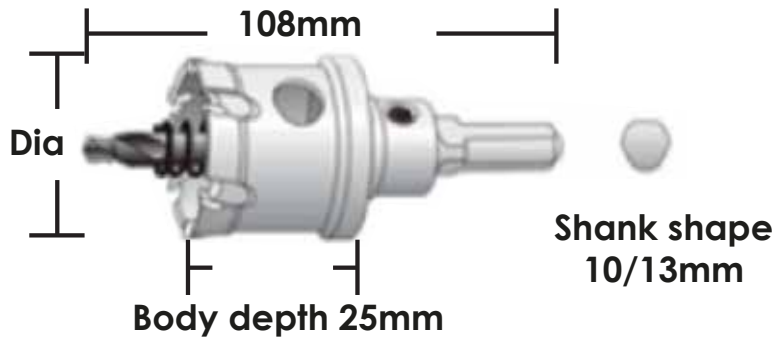

TECHNICAL DATA

Barcode	Keyhole	DIAMETER (mm)	No. carbide tips
9640077014	LC-C070014	14	4
9640077015	LC-C070015	15	4
9640077016	LC-C070016	16	4
9640077017	LC-C070017	17	4
9640077018	LC-C070018	18	4
9640077019	LC-C070019	19	4
9640077020	LC-C070020	20	6
9640077021	LC-C070021	21	4
9640077022	LC-C070022	22	6
9640077023	LC-C070023	23	6
9640077024	LC-C070024	24	6
9640077025	LC-C070025	25	6
9640077026	LC-C070026	26	6
9640077027	LC-C070027	27	6
9640077028	LC-C070028	28	6
9640077029	LC-C070029	29	6
9640077030	LC-C070030	30	6
9640077032	LC-C070032	32	6
9640077033	LC-C070033	33	6
9640077035	LC-C070035	35	9
9640077037	LC-C070037	37	9
9640077038	LC-C070038	38	9
9640077040	LC-C070040	40	9
9640077041	LC-C070041	41	9

Barcode	Keyhole	DIAMETER (mm)	No. carbide tips
964007700042	LC-C070042	42	9
964007700044	LC-C070044	44	9
964007700045	LC-C070045	45	9
964007700048	LC-C070048	48	9
964007700050	LC-C070050	50	9
964007700051	LC-C070051	51	10
964007700052	LC-C070052	52	10
964007700053	LC-C070053	53	10
964007700054	LC-C070054	54	10
964007700055	LC-C070055	55	10
964007700060	LC-C070060	60	10
964007700063	LC-C070063	63	12
964007700065	LC-C070065	65	12
964007700070	LC-C070070	70	12
964007700075	LC-C070075	75	12
964007700080	LC-C070080	80	15
964007700085	LC-C070085	85	15
964007700090	LC-C070090	90	15
964007700100	LC-C070100	100	18
964007700114	LC-C070114	114	21
964007700152	LC-C070152	152	22
964007700200	LC-C070200	200	24

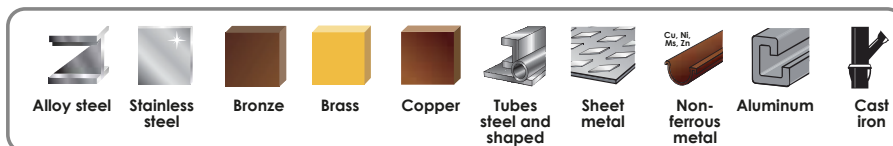

Bi-Metal Hole Saw



TECHNICAL DATA

		DIAMETER (mm)
9640078014	PT0101014	14
9640078016	PT0101016	16
9640078017	PT0101017	17
9640078019	PT0101019	19
9640078020	PT0101020	20
9640078021	PT0101021	21
9640078022	PT0101022	22
9640078023	PT0101023	23
9640078024	PT0101024	24
9640078025	PT0101025	25
9640078026	PT0101026	26
9640078027	PT0101027	27
9640078028	PT0101028	28
9640078029	PT0101029	29
9640078030	PT0101030	30
9640078031	PT0101031	31
9640078032	PT0101032	32
9640078033	PT0101033	33
9640078034	PT0101034	34
9640078035	PT0101035	35
9640078037	PT0101037	37
9640078038	PT0101038	38
9640078039	PT0101039	39
9640078040	PT0101040	40
9640078041	PT0101041	41
9640078042	PT0101042	42
9640078043	PT0101043	43
9640078044	PT0101044	44
9640078045	PT0101045	45
9640078046	PT0101046	46
9640078048	PT0101048	48
9640078050	PT0101050	50
9640078051	PT0101051	51
9640078052	PT0101052	52
9640078054	PT0101054	54
9640078056	PT0101056	56
9640078057	PT0101057	57
9640078058	PT0101058	58
9640078059	PT0101059	59
9640078060	PT0101060	60

		DIAMETER (mm)
9640078062	PT0101062	62
9640078064	PT0101064	64
9640078065	PT0101065	65
9640078067	PT0101067	67
9640078070	PT0101070	70
9640078073	PT0101073	73
9640078075	PT0101075	75
9640078076	PT0101076	76
9640078079	PT0101079	79
9640078080	PT0101080	80
9640078082	PT0101082	82
9640078083	PT0101083	83
9640078086	PT0101086	86
9640078089	PT0101089	89
9640078092	PT0101092	92
9640078095	PT0101095	95
9640078097	PT0101097	97
9640078100	PT0101100	100
9640078102	PT0101102	102
9640078105	PT0101105	105
9640078108	PT0101108	108
9640078111	PT0101111	111
9640078114	PT0101114	114
9640078121	PT0101121	121
9640078127	PT0101127	127
9640078133	PT0101133	133
9640078140	PT0101140	140
9640078146	PT0101146	146
9640078152	PT0101152	152
9640078178	PT0101178	178
9640078200	PT0101200	200
9640078210	PT0101210	210
9640078250	PT0101250	250
9640079509	PT0103001	16-51
9640079512	PT0103009	19-64

Set 9Pcs

Set 12Pcs



TCT Hole Saw for Metal



1-9mm
Stainless Steel



Aluminum
Alloy



Within 25mm
Copper

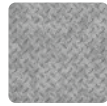

Within 25mm
Steel Plate



TECHNICAL DATA

Barcode	Model	DIAMETER (mm)	No. carbide tips
964007700014	LC-C070014	14	4
964007700015	LC-C070015	15	4
964007700016	LC-C070016	16	4
964007700017	LC-C070017	17	4
964007700018	LC-C070018	18	4
964007700019	LC-C070019	19	4
964007700020	LC-C070020	20	6
964007700021	LC-C070021	21	6
964007700022	LC-C070022	22	6
964007700023	LC-C070023	23	6
964007700024	LC-C070024	24	6
964007700025	LC-C070025	25	6
964007700026	LC-C070026	26	6
964007700027	LC-C070027	27	6
964007700028	LC-C070028	28	6
964007700029	LC-C070029	29	6
964007700030	LC-C070030	30	6
964007700032	LC-C070032	32	6
964007700033	LC-C070033	33	6
964007700034	LC-C070034	34	6
964007700035	LC-C070035	35	9
964007700036	LC-C070036	36	9
964007700038	LC-C070038	38	9
964007700040	LC-C070040	40	9

Barcode	Model	DIAMETER (mm)	No. carbide tips
964007700041	LC-C070041	41	9
964007700042	LC-C070042	42	9
964007700044	LC-C070044	44	9
964007700045	LC-C070045	45	9
964007700048	LC-C070048	48	9
964007700050	LC-C070050	50	9
964007700051	LC-C070051	51	10
964007700052	LC-C070052	52	10
964007700053	LC-C070053	53	10
964007700054	LC-C070054	54	10
964007700055	LC-C070055	55	10
964007700060	LC-C070060	60	10
964007700063	LC-C070063	63	12
964007700065	LC-C070065	65	12
964007700070	LC-C070070	70	12
964007700075	LC-C070075	75	12
964007700080	LC-C070080	80	15
964007700085	LC-C070085	85	15
964007700090	LC-C070090	90	15
964007700100	LC-C070100	100	18
964007700114	LC-C070114	114	21
964007700152	LC-C070152	152	22
964007700200	LC-C070200	200	24

CUTTING DISCS



STANDARD



Applications

- Unalloyed and alloyed construction steel
- High alloy special steel
- Angular steel profiles
- Stainless steel

Tool

- Angle Grinder

Advantages

- Durable
- Productive
- Cost efficient
- Reduced heat generation
- Treated against moisture for longer life time

Types

- T 41
- T 42

TECHNICAL DATA

Item Number			Peripheral Speed (m/s)	Max R.P.M	Packet Qty	Gw/Ctn	Vol/Ctn	Origin	Type
9605351153022	APTP21153022	115 × 3.0 × 22.2	80	13300	200	-	-	CHN	T42
9605351253022	APTP21253022	125 × 3.0 × 22.2	80	12200	200	-	-	CHN	T42

CUTTING DISCS



PROFESSIONAL



Applications

- Unalloyed and alloyed construction steel
- High alloy special steel
- Angular steel profiles
- Stainless steel

Tool

- Angle Grinder

Advantages

- Durable
- Productive
- Cost efficient
- Reduced heat generation
- Treated against moisture for longer life time

Types

- T 41
- T 42

TECHNICAL DATA

Item Number			Peripheral Speed (m/s)	Max R.P.M	Packet Qty	Gw/Ctn	Vol/Ctn	Origin	Type
9605401151024	APTP11151022	115 × 1.0 × 22.2	80	13300	400	11.61	0.009	CHN	T41
9605401251024	APTP11251022	125 × 1.0 × 22.2	80	12200	400	13.80	0.011	CHN	T41
9605402301924	APTP12301922	230 × 1.9 × 22.2	80	6650	100	19.47	0.016	CHN	T41
9605451801622	APTP21801622	180 × 1.6 × 22.2	80	8500	200	18.40	0.016	CHN	T42
9605402301922	APTP22301922	230 × 1.9 × 22.2	80	6650	100	19.96	0.016	CHN	T42

CUTTING DISCS



PROFESSIONAL



Applications

- Unalloyed and alloyed construction steel
- High alloy special steel
- Angular steel profiles
- Stainless steel

Tool

- Angle Grinder

Advantages

- Durable
- Productive
- Cost efficient
- Reduced heat generation
- Treated against moisture for longer life time

Types

- T 41 
- T 42 

TECHNICAL DATA

Item Number			Peripheral Speed (m/s)	Max R.P.M	Packet Qty	Gw/Ctn	Vol/Ctn	Origin	Type
9605451153022	APTP21153022	115 × 3.0 × 22.2	80	13300	200	14.69	0.014	CHN	T42
9605451253022	APTP21253022	125 × 3.0 × 22.2	80	12200	200	17.39	0.016	CHN	T42
9605451803022	APTP21803022	180 × 3.0 × 22.2	80	8500	100	19.10	0.016	CHN	T42
9605452303022	APTP22303022	230 × 3.0 × 22.2	80	6650	50	15.56	0.014	CHN	T42

CUTTING DISCS



INDUSTRIAL



Applications

- Unalloyed and alloyed construction steel
- High alloy special steel
- Angular steel profiles
- Stainless steel

Tool

- Angle Grinder

Advantages

- Durable
- Productive
- Cost efficient
- Reduced heat generation
- Treated against moisture for longer life time

Types

- T 41 
- T 42 

TECHNICAL DATA

Item Number			Peripheral Speed (m/s)	Max R.P.M	Packet Qty	Gw/Ctn	Vol/Ctn	Origin	Type
9605501151024	APTI11151022	115 × 1.0 × 22.2	80	13300	400	11.59	0.009	CHN	T41
9605501251024	APTI11251022	125 × 1.0 × 22.2	80	12200	400	14.07	0.011	CHN	T41
9605501251224	APTI11251222	125 × 1.2 × 22.2	80	12200	400	13.79	0.012	CHN	T41
9605501251624	APTI11251622	125 × 1.6 × 22.2	80	12200	400	15.98	0.013	CHN	T41
9605501801624	APTI11801622	180 × 1.6 × 22.2	80	8500	200	18.67	0.016	CHN	T41
9605502301924	APTI12301922	230 × 1.9 × 22.2	80	6650	100	19.48	0.016	CHN	T41
9605502301922	APTI22301922	230 × 1.9 × 22.2	80	6650	100	19.87	0.016	CHN	T42

CUTTING DISCS



INDUSTRIAL EXTREME



Applications

- Unalloyed and alloyed construction steel
- High alloy special steel
- Angular steel profiles
- Stainless steel

Tool

- Angle Grinder

Advantages

- Durable
- Productive
- Cost efficient
- Reduced heat generation
- Treated against moisture for longer life time

Types

- T 41
- T 42

TECHNICAL DATA

Item Number			Peripheral Speed (m/s)	Max R.P.M	Packet Qty	Gw/Ctn	Vol/Ctn	Origin	Type
9605501251824	APT111251822	125 × 1.6 × 22.2	80	12200	400	-	-	CHN	T41

CUTTING DISCS



INDUSTRIAL



Applications

- Unalloyed and alloyed construction steel
- High alloy special steel
- Angular steel profiles
- Stainless steel

Tool

- Angle Grinder

Advantages

- Durable
- Productive
- Cost efficient
- Reduced heat generation
- Treated against moisture for longer life time

Types

- T 41
- T 42

TECHNICAL DATA

Item Number			Peripheral Speed (m/s)	Max R.P.M	Packet Qty	Gw/Ctn	Vol/Ctn	Origin	Type
9605551153022	APT121153022	115 × 3.0 × 22.2	80	13300	200	14.72	0.014	CHN	T42
9605551253022	APT121253022	125 × 3.0 × 22.2	80	12200	200	17.70	0.016	CHN	T42
9605551803022	APT181803022	180 × 3.0 × 22.2	80	8500	100	18.94	0.012	CHN	T42
9605552303022	APT122303022	230 × 3.0 × 22.2	80	6650	50	15.64	0.014	CHN	T42

GRINDING DISCS



STANDARD



Applications

- Unalloyed and alloyed construction steel
- High alloy special steel
- Stainless sheet steel
- Non-ferrous metals

Tool

- Angle Grinder

Advantages

- Extended life time
- High quality abrasive grain
- Easy working
- Cost efficient
- High stock removal rate

Types

- T 27



TECHNICAL DATA

Item Number			Peripheral Speed (m/s)	Max R.P.M	Packet Qty	Gw/Ctn	Vol/Ctn	Origin	Type
9605401156022	APTP71156022	115 × 6.0 × 22.2	80	13300	100	15.52	0.012	CHN	T27
9605351256022	APTP71256022	125 × 6.0 × 22.2	80	12200	100	-	-	CHN	T27
9605351806022	APTP71806022	180 × 6.0 × 22.2	80	8500	50	-	-	CHN	T27

GRINDING DISCS



PROFESSIONAL



Applications

- Unalloyed and alloyed construction steel
- High alloy special steel
- Stainless sheet steel
- Non-ferrous metals

Tool

- Angle Grinder

Advantages

- Extended life time
- High quality abrasive grain
- Easy working
- Cost efficient
- High stock removal rate

Types

- T 27



TECHNICAL DATA

Item Number			Peripheral Speed (m/s)	Max R.P.M	Packet Qty	Gw/Ctn	Vol/Ctn	Origin	Type
9605451256022	APTP71256022	125 × 6.0 × 22.2	80	12200	100	18.02	0.013	CHN	T27
9605451806022	APTP71806022	180 × 6.0 × 22.2	80	8500	50	19.41	0.013	CHN	T27
9605452306022	APTP72306022	230 × 6.0 × 22.2	80	6650	30	18.30	0.013	CHN	T27

GRINDING DISCS



INDUSTRIAL



Applications

- Unalloyed and alloyed construction steel
- High alloy special steel
- Stainless sheet steel
- Non-ferrous metals

Tool

- Angle Grinder

Advantages

- Extended life time
- High quality abrasive grain
- Easy working
- Cost efficient
- High stock removal rate

Types

- T 27



TECHNICAL DATA

Item Number			Peripheral Speed (m/s)	Max R.P.M	Packet Qty	Gw/Ctn	Vol/Ctn	Origin	Type
9605551256022	APTI71256022	125 × 6.0 × 22.2	80	12200	100	18.49	0.013	CHN	T27
9605551806022	APTI71806022	180 × 6.0 × 22.2	80	8500	50	19.91	0.012	CHN	T27
9605552306022	APTI72306022	230 × 6.0 × 22.2	80	6650	30	19.04	0.013	CHN	T27

GRINDING DISCS



INDUSTRIAL



Applications

- Unalloyed and alloyed construction steel
- High alloy special steel
- Stainless sheet steel
- Non-ferrous metals

Tool

- Angle Grinder

Advantages

- Extended life time
- High quality abrasive grain
- Easy working
- Cost efficient
- High stock removal rate

Types

- T 27



TECHNICAL DATA

Item Number			Peripheral Speed (m/s)	Max R.P.M	Packet Qty	Gw/Ctn	Vol/Ctn	Origin	Type
9605582300722	APTI72307022	230 × 7.0 × 22.2	80	6650	30	19.28	013	CHN	T27

CUT-OFF DISCS



Applications

- 8mm I-steel Rails
- Thin-walled tubes
- Unalloyed and alloyed steel
- High alloy special steel
- Angular steel profiles

Tool

- Fixed Cutting Bench



Advantages

- Durable
- Productive
- Cost efficient
- Reduced heat generation
- Less noise

Types

- T 41 

TECHNICAL DATA

Item Number			Peripheral Speed (m/s)	Max R.P.M	Packet Qty	Gw/Ctn	Vol/Ctn	Origin	Type
9605453503526	APTP13503525	350 × 3.5 × 25.4	80	4400	25	18.53	0.013	CHN	T41
9605453504026	APTP13504025	350 × 4.0 × 25.4	80	4400	25	21.46	0.016	CHN	T41

CUT-OFF DISCS



INDUSTRIAL



Applications

- 8mm I-steel Rails
- Thin-walled tubes
- Unalloyed and alloyed steel
- High alloy special steel
- Angular steel profiles

Tool

- Fixed Cutting Bench



Advantages

- Durable
- Productive
- Cost efficient
- Reduced heat generation
- Less noise

Types

- T 41 

TECHNICAL DATA

Item Number			Peripheral Speed (m/s)	Max R.P.M	Packet Qty	Gw/Ctn	Vol/Ctn	Origin	Type
9605553003526	APTI13003525	300 × 3.5 × 25.4	80	5100	25	13.59	0.010	CHN	T41
9605553503526	APTI13503525	350 × 3.5 × 25.4	80	4400	25	18.81	0.013	CHN	T41
9605553504026	APTI13504025	350 × 4.0 × 25.4	80	4400	25	22.11	0.016	CHN	T41

ALUMINUM OXIDE RESIN FIBRE DISCS

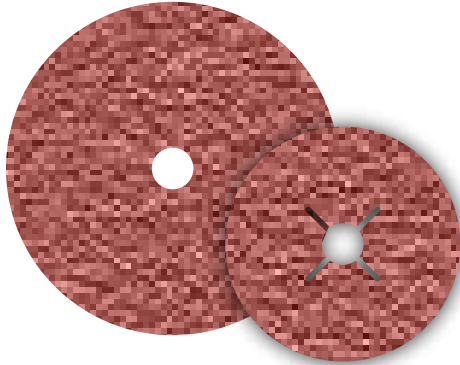

Composition

- Heat-treated Aluminum oxide grain
- Vulcanized fibre backing
- Resin on resin bond

Advantages

- Strong, long life
- High stock removal
- Cool cutting
- resistant to heat and moisture
- Fast and aggressive
- High abrasive power
- Low overheating.

Applications

Stripping paint on metal wood, and fiberglass, Deburring, Polishing, Grinding

Shapes



Flat

- A Aluminum oxide
- RR Resins
- CL Closed

TECHNICAL DATA

			Bore		Grits								
					24	36	40	50	60	80	100	120	
		115 × 22.23				●	●	●		●	●	●	●
		125 × 22.23				●	●	●		●	●	●	●
		180 × 22.23				●	●	●		●	●	●	●

- Round bore
- Round bore with 4 slots
- Round bore with 8 slots
- Available on demand only (Not regularly produced)

ZIRCONIA RESIN FIBRE DISCS

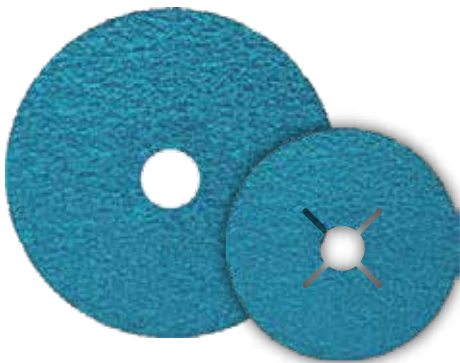

Composition

- Premium Zirconia abrasive grain
- Vulcanized fibre backing
- Resin on resin bond

Advantages

- Toughest and most aggressive grain
- Extremely long life
- High stock removal
- cuts cool and self sharpens
- Strength-resistant to heat and moisture
- Fast and aggressive.
- High abrasive power.
- Low overheating

Applications

Grinding, Deburring, Polishing, stripping of metal and stainless steel

Shapes



Flat

- Z Zirconia
- RR Resins
- CL Closed

TECHNICAL DATA

			Bore		Grits								
					24	36	40	50	60	80	100	120	
		115 × 22.23				●	●	●		●	●	●	●
		125 × 22.23				●	●	●		●	●	●	●
		180 × 22.23				●	●	●		●	●	●	●

- Round bore
- Round bore with 4 slots
- Round bore with 8 slots
- Available on demand only (Not regularly produced)

CERAMIC RESIN FIBRE DISCS

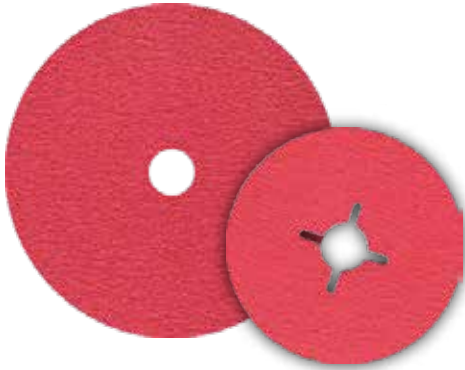

Composition

- Premium Ceramic abrasive grain
- Vulcanized fibre backing
- Resin on resin bond

Advantages

- Strong, long life
- High stock removal
- Cool cutting
- resistant to heat and moisture
- Fast and aggressive
- High abrasive power
- Low overheating

Applications

Stripping paint on stainless steel, alloy, titanium alloy high hardness materials

Shapes



- C Ceramic
- RR Resins
- CL Closed

TECHNICAL DATA

			Bore		Grits								
					24	36	40	50	60	80	100	120	
		115 × 22.23											
		125 × 22.23											
		180 × 22.23											

- Round bore
- Round bore with 4 slots
- Round bore with 8 slots
- Available on demand only (Not regularly produced)

SILICON CARBIDE RESIN FIBRE DISCS



Composition

- Heat-treated Aluminum oxide grain
- Vulcanized fibre backing
- Resin on resin bond

Advantages

- Strong, long life
- High stock removal
- Cool cutting
- resistant to heat and moisture
- Fast and aggressive
- High abrasive power
- Low overheating

Applications

stripping paint on grinding, polishing on marble granite, glass

Shapes



- S Silicon carbide
- RR Resins
- CL Closed

TECHNICAL DATA

			Bore		Grits									
					16	24	36	40	60	80	120	180	220	
		115 × 22.23												
		125 × 22.23												
		180 × 22.23												

- Round bore
- Round bore with 4 slots
- Round bore with 8 slots
- Available on demand only (Not regularly produced)

ALUMINUM OXIDE VELCRO SANDING DISCS

PRO



Composition

Grain: Premium aluminum oxide
Backing: Cwt latex paper
Bond: Resin on resin

Applications

Dry sanding, Drywall,
Wood products,
Fiberglass, Paint and primer

Advantages

Fast cutting, Excellent finish, Quick change, Strong adhesion,
Heat resistant, anti-static, good flexibility, wear resisting

A Aluminum oxide **LU** With Lubricant **RR** Resins **OP** Open

TECHNICAL DATA

Barcode	Key	Size	Grits
	DW215104	Ø 125 ●	40
	DW215106	Ø 125 ●	60
	DW215108	Ø 125 ●	80
	DW215110	Ø 125 ●	100
	DW215112	Ø 125 ●	120
	DW215115	Ø 125 ●	150
	DW215118	Ø 125 ●	180
	DW215124	Ø 125 ●	240
	DW215132	Ø 125 ●	320
	DW215304	Ø 150 ●	40
	DW215306	Ø 150 ●	60
	DW215308	Ø 150 ●	80
	DW215310	Ø 150 ●	100
	DW215312	Ø 150 ●	120

Barcode	Key	Size	Grits
	DW215315	Ø 150 ●	150
	DW215318	Ø 150 ●	180
	DW215324	Ø 150 ●	240
	DW215332	Ø 150 ●	320
	DW215404	Ø 180 ●	40
	DW215406	Ø 180 ●	60
	DW215408	Ø 180 ●	80
	DW215410	Ø 180 ●	100
	DW215412	Ø 180 ●	120
	DW215415	Ø 180 ●	150
	DW215418	Ø 180 ●	180
	DW215424	Ø 180 ●	240
	DW215432	Ø 180 ●	320

● without holes ● 6 holes ● 14 holes

ALUMINUM OXIDE VELCRO SANDING DISCS

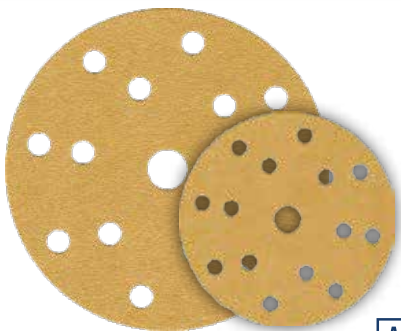

Composition

Grain: Calcine aluminum oxide
(gold stearate)
Backing: Wt latex paper
Bond: Resin on resin

Applications

Automotive, Drywall,
Wood products, Metal,
furniture

Advantages

Fast cutting, Excellent finish, Quick change, Strong adhesion,
Heat resistant, Highly durable

A Aluminum oxide **LU** With Lubricant **RR** Resins **OP** Open

TECHNICAL DATA

Barcode	Key	Size	Grits
	DW213904	Ø 150 ●	40
	DW213906	Ø 150 ●	60
	DW213908	Ø 150 ●	80
	DW213910	Ø 150 ●	100
	DW213912	Ø 150 ●	120
	DW213915	Ø 150 ●	150
	DW213918	Ø 150 ●	180
	DW213922	Ø 150 ●	220
	DW213924	Ø 150 ●	240
	DW213932	Ø 150 ●	320
	DW213940	Ø 150 ●	400

● without holes ● 6 holes ● 14 holes

ALUMINUM OXIDE VELCRO SANDING DISCS

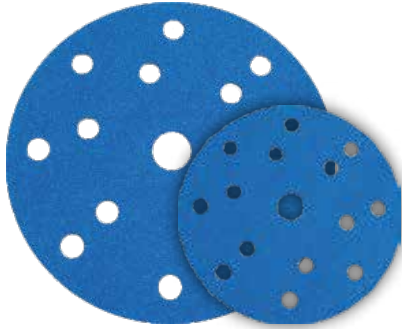

Composition

Grain: Ceramic
 Backing: CWt latex paper
 Bond: Resin on resin

Applications

Automotive, Wood products,
 Metal (Aluminum, Copper),
 Fiberglass, Paint and primer

Advantages

Fast cutting, Excellent finish, Quick change, Strong adhesion,
 Heat resistant, Highly durable

SG Ceramic **LU** With Lubricant **RR** Resins **OP** Open

TECHNICAL DATA

Barcode	Key	Size	Grits
	DW214908	Ø 150	80
	DW214910	Ø 150	100
	DW214912	Ø 150	120
	DW214915	Ø 150	150
	DW214918	Ø 150	180
	DW214924	Ø 150	240
	DW214932	Ø 150	320
	DW214940	Ø 150	400
	DW214960	Ø 150	600

without holes 6 holes 14 holes

ALUMINUM OXIDE VELCRO SANDING DISCS

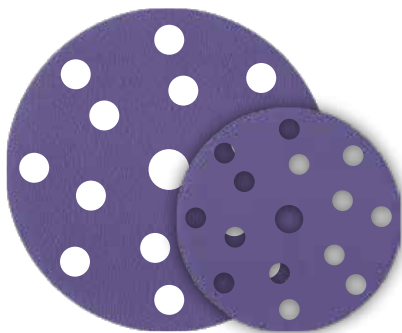

Composition

Grain: Ceramic
 Backing: PTU film
 Bond: Resin on resin

Applications

Automotive, Wood, Metal,
 drywall,
 epoxy and painted surfaces,
 wet sanding

Advantages

More durable and reusable, Less clogging, smoother finish,
 Quick change, Strong adhesion, Heat resistant

SG Ceramic **LU** With Lubricant **RR** Resins **OP** Open

TECHNICAL DATA

Barcode	Key	Size	Grits
	DW215908	Ø 150	80
	DW215910	Ø 150	100
	DW215912	Ø 150	120
	DW215915	Ø 150	150
	DW215918	Ø 150	180
	DW215924	Ø 150	240
	DW215932	Ø 150	320
	DW215940	Ø 150	400
	DW215960	Ø 150	600
	DW215980	Ø 150	800
	DW215981	Ø 150	1000
	DW215982	Ø 150	1500
	DW215983	Ø 150	2000

without holes 6 holes 14 holes

ALUMINUM OXIDE VELCRO SANDING DISCS

PRO

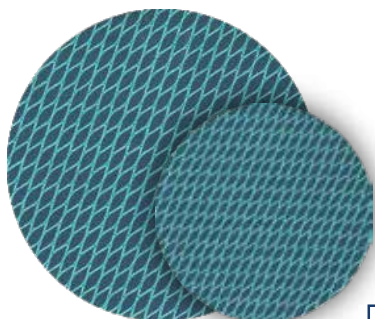

Composition

Grain: Premium aluminum oxide
 Backing: Jwf Cloth
 Bond: Resin on resin

Applications

Wet-dry polishing,
 Woodworking, Metalworking,
 Automotive maintenance,
 Wall decoration, Craft making

Advantages

Super Anti-clog, Fast cutting, Quick change, Strong adhesion,
 Heat resistant.

A Aluminum oxide **LU** With Lubricant **RR** Resins **OP** Open

TECHNICAL DATA

Barcode	Key	Icon	Grits
	DW217106	Ø 125 ●	60
	DW217108	Ø 125 ●	80
	DW217110	Ø 125 ●	100
	DW217112	Ø 125 ●	120
	DW217115	Ø 125 ●	150
	DW217118	Ø 125 ●	180
	DW217124	Ø 125 ●	240
	DW217132	Ø 125 ●	320
	DW217306	Ø 150 ●	60
	DW217308	Ø 150 ●	80
	DW217310	Ø 150 ●	100
	DW217312	Ø 150 ●	120

Barcode	Key	Icon	Grits
	DW217315	Ø 150 ●	150
	DW217318	Ø 150 ●	180
	DW217324	Ø 150 ●	240
	DW217332	Ø 150 ●	320
	DW217406	Ø 180 ●	60
	DW217408	Ø 180 ●	80
	DW217410	Ø 180 ●	100
	DW217412	Ø 180 ●	120
	DW217415	Ø 180 ●	150
	DW217418	Ø 180 ●	180
	DW217424	Ø 180 ●	240
	DW217432	Ø 180 ●	320

● without holes ● 6 holes ● 14 holes

Aluminium Oxide Flap Disc



STANDARD

FEATURES

Aluminum Oxide / Zirconia grain
Fiberglass backing
Heavy X-weight backing
Available with 5/8"-11 threaded hub

BENEFITS

Fast and cool cutting
No need to switch from grinding wheel to resin fiber disc
Grinding, blend, and finish in one easy step



TECHNICAL DATA

Type 27

Item Number			Grit		
960350422104	DW422104	115x22.23	40	10	200
960350422106	DW422106	115x22.23	60	10	200
960350422108	DW422108	115x22.23	80	10	200
960350422110	DW422110	115x22.23	100	10	200
960350422112	DW422112	115x22.23	120	10	200
960350422304	DW422304	125x22.23	40	10	200
960350422306	DW422306	125x22.23	60	10	200
960350422308	DW422308	125x22.23	80	10	200
960350422310	DW422310	125x22.23	100	10	200
960350422312	DW422312	125x22.23	120	10	200

APPLICATIONS

All-purpose sanding and grinding
Ferrous and non-ferrous metals
Best for welds and blending
Rust removal
Light deburring



Flat shaped for working on flat grinding surfaces. Most efficient when used between 0° to 15° angle. Best choice for smooth finishing.

Aluminium Oxide Flap Disc



STANDARD

FEATURES

Aluminum Oxide / zirconia grain
Fiberglass backing
Heavy X-weight backing
Available with 5/8"-11 threaded hub

BENEFITS

Resin on resin bond
Fast and cool cutting
No need to switch from grinding wheel to resin fiber disc
Grinding, blend, and finish in one easy step



TECHNICAL DATA

Type 29

Item Number			Grit		
960350423104	DW423104	115x22.23	40	10	200
960350423106	DW423106	115x22.23	60	10	200
960350423108	DW423108	115x22.23	80	10	200
960350423110	DW423110	115x22.23	100	10	200
960350423304	DW423304	125x22.23	40	10	200
960350423306	DW423306	125x22.23	60	10	200
960350423308	DW423308	125x22.23	80	10	200

APPLICATIONS

For sanding heavy metal and stainless steel
Best for welds and blending
Rust removal & deburring

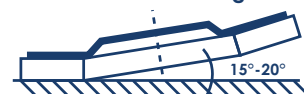

Conical shaped flaps are angled at 10° which is ideal for contour and edge work. Angled flaps provide greater surface contact for a more aggressive cut. Most efficient when used between 15° to 25° angle.

Aluminium Oxide Flap Disc



PROFESSIONAL

FEATURES

Aluminum Oxide / Zirconia grain
Fiberglass backing
Heavy X-weight backing
Available with 5/8"-11 threaded hub

BENEFITS

Fast and cool cutting
No need to switch from grinding wheel to resin fiber disc
Grinding, blend, and finish in one easy step



TECHNICAL DATA

Type 27

Item Number			Grit		
960350426110	DW426110	115x22.23	100	10	200
960350426304	DW426304	125x22.23	40	10	200
960350426306	DW426306	125x22.23	60	10	200
960350426308	DW426308	125x22.23	80	10	200
960350426310	DW426310	125x22.23	100	10	200
960350426312	DW426312	125x22.23	120	10	200
960350426504	DW426504	180x22.23	40	10	100
960350426506	DW426506	180x22.23	60	10	100
960350426508	DW426508	180x22.23	80	10	100

APPLICATIONS

All-purpose sanding and grinding
Ferrous and non-ferrous metals
Best for welds and blending
Rust removal
Light deburring



Flat shaped for working on flat grinding surfaces. Most efficient when used between 0° to 15° angle. Best choice for smooth finishing.

Aluminium Oxide Flap Disc



PROFESSIONAL

FEATURES

Aluminum Oxide / zirconia grain
Fiberglass backing
Heavy X-weight backing
Available with 5/8"-11 threaded hub

BENEFITS

Resin on resin bond
Fast and cool cutting
No need to switch from grinding wheel to resin fiber disc
Grinding, blend, and finish in one easy step



TECHNICAL DATA

Type 29

Item Number			Grit		
960350427106	DW427106	115x22.23	60	10	200
960350427108	DW427108	115x22.23	80	10	200
960350427304	DW427304	125x22.23	40	10	200
960350427306	DW427306	125x22.23	60	10	200
960350427308	DW427308	125x22.23	80	10	200
960350427310	DW427310	125x22.23	100	10	200
960350427312	DW427312	125x22.23	120	10	200

APPLICATIONS

For sanding heavy metal and stainless steel
Best for welds and blending
Rust removal & deburring

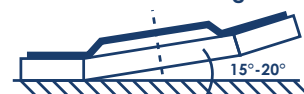

Conical shaped flaps are angled at 10° which is ideal for contour and edge work. Angled flaps provide greater surface contact for a more aggressive cut. Most efficient when used between 15° to 25° angle.

Zirconia Flap Disc



INDUSTRIAL

FEATURES

Aluminum Oxide / Zirconia grain
Fiberglass backing
Heavy X-weight backing
Available with 5/8"-11 threaded hub

BENEFITS

Fast and cool cutting
No need to switch from grinding wheel to resin fiber disc
Grinding, blend, and finish in one easy step

TECHNICAL DATA

Type 27

Item Number			Grit		
960350428104	DW428104	115x22.23	40	10	200
960350428106	DW428106	115x22.23	60	10	200
960350428108	DW428108	115x22.23	80	10	200
960350428112	DW428112	115x22.23	120	10	200
960350428304	DW428304	125x22.23	40	10	200
960350428306	DW428306	125x22.23	60	10	200
960350428308	DW428308	125x22.23	80	10	200
960350428310	DW428310	125x22.23	100	10	200
960350428312	DW428312	125x22.23	120	10	200
960350428504	DW428504	180x22.23	40	10	100
960350428506	DW428506	180x22.23	60	10	100
960350428508	DW428508	180x22.23	80	10	100



APPLICATIONS

All-purpose sanding and grinding
Ferrous and non-ferrous metals
Best for welds and blending
Rust removal
Light deburring



Flat shaped for working on flat grinding surfaces. Most efficient when used between 0° to 15° angle. Best choice for smooth finishing.

Zirconia Flap Disc



INDUSTRIAL

FEATURES

Aluminum Oxide / zirconia grain
Fiberglass backing
Heavy X-weight backing
Available with 5/8"-11 threaded hub

BENEFITS

Resin on resin bond
Fast and cool cutting
No need to switch from grinding wheel to resin fiber disc
Grinding, blend, and finish in one easy step

TECHNICAL DATA

Type 29

Item Number			Grit		
960350429106	DW429106	115x22.23	60	10	200
960350429108	DW429108	115x22.23	80	10	200
960350429304	DW429304	125x22.23	40	10	200
960350429306	DW429306	125x22.23	60	10	200
960350429308	DW429308	125x22.23	80	10	200
960350429310	DW429310	125x22.23	100	10	200
960350429312	DW429312	125x22.23	120	10	200



APPLICATIONS

For sanding heavy metal and stainless steel
Best for welds and blending
Rust removal & deburring

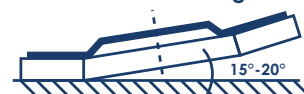

Conical shaped flaps are angled at 10° which is ideal for contour and edge work. Angled flaps provide greater surface contact for a more aggressive cut. Most efficient when used between 15° to 25° angle.

Ceramic Flap Disc



INDUSTRIAL

FEATURES

Premium ceramic abrasive grain
Fiberglass backing
Heavy X-weight backing
Available with 5/8"-11 threaded hub

BENEFITS

Fast and cool cutting
No need to switch from grinding wheel to resin fiber disc
Grinding, blend, and finish in one easy step



TECHNICAL DATA

Type 27

Item Number			Grit		
960350438104	DW438104	115x22.23	40	10	200
960350438106	DW438106	115x22.23	60	10	200
960350438108	DW438108	115x22.23	80	10	200
960350438112	DW438112	115x22.23	120	10	200
960350438304	DW438304	125x22.23	40	10	200
960350438306	DW438306	125x22.23	60	10	200
960350438308	DW438308	125x22.23	80	10	200
960350438312	DW438312	125x22.23	120	10	200



Flat shaped for working on flat grinding surfaces. Most efficient when used between 0° to 15° angle. Best choice for smooth finishing.

APPLICATIONS

All-purpose sanding and grinding
Ferrous and non-ferrous metals
Titanium, Alloy & Stainless Steel
Best for welds and blending
Rust removal
Light deburring

Diamond Saw Blade Ring

It is specially designed for clean, chip-free cutting of various kind of marble tiles, ceramic tiles and porcelain in the construction



TECHNICAL DATA

Item Number			Segment Thickness mm	Segment Height mm
960200204100	DW200204-4	100	1.2	8

Diamond Saw Blade Turbo

It is specially designed for clean, chip-free cutting of various kind of marble tiles, ceramic tiles and porcelain in the construction



TECHNICAL DATA

Item Number			Segment Thickness mm	Segment Height mm
960200214100	DW200214-4	100	1.2	8
960200214115	DW200214-4.5	115	1.2	8
960200214125	DW200214-5	120	1.4	8

High Frequency Core Bit

Self cooling
 Self sharpening
 Fast and clean cuts
 Vacuum welded
 M14 thread for use on a regular grinder



Brick

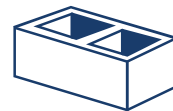

Concrete

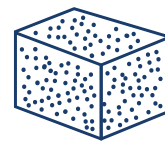

Cement walls

TECHNICAL DATA

Item Number		
	DW208654-06	6×100
	DW208654-08	8×100
	DW208654-10	10×100
	DW208654-12	12×100
	DW208654-14	14×100
	DW208654-15	15×100
	DW208654-18	18×100
	DW208654-20	20×100
	DW208654-22	22×100
	DW208654-25	25×100
	DW208654-30	30×100
	DW208654-35	35×100
	DW208654-40	40×100

Item Number		
	DW208654-50	50×100
	DW208654-60	60×100
	DW208654-70	70×100
	DW208654-80	80×100
	DW208654-90	90×100
	DW208654-100	100×100
	DW208654-120	120×100
	DW208654-130	130×100
	DW208654-140	140×100
	DW208654-150	150×100
	DW208654-165	165×100
	DW208654-180	180×100
	DW208654-200	200×100

Vacuum Brazed Core Bit

Self cooling
 Self sharpening
 Fast and clean cuts
 Vacuum brazed
 M14 thread for use on a regular grinder



TECHNICAL DATA

Item Number		
	DW208930-06	6×75
	DW208930-08	8×75
	DW208930-10	10×75
	DW208930-12	12×75
	DW208930-15	15×75
	DW208930-18	18×75
	DW208930-20	20×75
	DW208930-22	22×75
	DW208930-25	25×75
	DW208930-30	30×75
	DW208930-35	35×75
	DW208930-40	40×75
	DW208930-50	50×75
	DW208930-60	60×75



DRY OR
WET USE



FAST, PRECISE
CLEAN HOLES



VACUUM
BRAZED
TECHNOLOGY



PERMANENT
DIAMOND
COATING

Diamond Saw Blade Turbo

It is specially designed for clean, chip-free cutting of various kind of marble tiles, ceramic tiles and porcelain in the construction



TECHNICAL DATA

Item Number			Segment Thickness mm	Segment Height mm
960200324115	DW200324-4.5	115	2.4	10
960200324125	DW200324-5	125	2.4	10
960200324180	DW200324-7	180	2.6	10
960200324230	DW200324-9	230	2.6	10

Diamond Saw Blade Turbo-X

It is specially designed for clean, chip-free cutting of various kind of marble tiles, ceramic tiles and porcelain in the construction



TECHNICAL DATA

Item Number			Segment Thickness mm	Segment Height mm
960200224100	DW200224-4	100	1.2	0.8
960200224115	DW200224-4.5	115	1.2	0.8
960200224125	DW200224-5	120	1.4	0.8

Diamond Saw Blade T Turbo

It is specially designed for clean, chip-free cutting of various kind of marble tiles, ceramic tiles and porcelain in the construction



TECHNICAL DATA

Item Number			Segment Thickness mm	Segment Height mm
960200554180	DW200554-7	180	2.8	10

Diamond Saw Blade Closed Rim (For Ceramics)

It is specially designed for clean, chip-free cutting of various kind of marble tiles, ceramic tiles and porcelain in the construction



TECHNICAL DATA

Item Number			Segment Thickness mm	Segment Height mm
960200361115	DW200361-4.5	115	2.4	10
960200224115	960200361125	125	2.4	10

General Purpose Vacuum Brazed Diamond Blade

More suitable for cutting all kinds of metal pipes, thin-walled stainless steel, threaded steel, angle steel, aluminum and other metals, HDPE and PVC plastic pipes, metal roof panels, metal plates and other metal materials, as well as ceramics, marble, various



TECHNICAL DATA

Item Number			Segment Thickness mm	Segment Length mm
960202310115	DW202310-4.5	115	1.2	32
960202310125	DW202310-5	125	1.2	32
960202310180	DW202310-7	180	1.8	32
960202310230	DW202310-9	230	1.8	38/40

Metal Cutting Vacuum Brazed Diamond Blade

More suitable for cutting all kinds of metal pipes, thin-walled stainless steel, threaded steel, angle steel, aluminum and other metals, HDPE and PVC plastic pipes, metal roof panels, metal plates and other metal materials, as well as ceramics, marble, various



TECHNICAL DATA



Item Number			Segment Thickness mm
960202320115	DW202320-4.5	115	1.2
960202320125	DW202320-5	125	1.2
960202320180	DW202320-7	180	1.8
960202320230	DW202320-9	230	2.0

Diamond Saw Blade Segment

The range is recommended for general cutting of masonry and concrete materials such as bricks, blocks, slate, stone and old concrete without steel bar.



TECHNICAL DATA



Item Number			Segment Thickness mm	Segment Height mm
960200314115	DW200314-4.5	115	2.4	10
960200314125	DW200314-5	125	2.4	10
960200314180	DW200314-7	180	2.6	10
960200314230	DW200314-9	230	2.8	10

2X Life Time Diamond Saw Blade Segment

The range is recommended for general cutting of masonry and concrete materials such as bricks, blocks, slate, stone and old concrete without steel bar.



TECHNICAL DATA

Item Number			Segment Thickness mm	Segment Height mm
960200316115	DW200316-4.5	115	2.4	12
960200316125	DW200316-5	125	2.4	12
960200316180	DW200316-7	180	2.6	12
960200316230	DW200316-9	230	2.8	12

3X Life Time Diamond Saw Blade Segment

The range is recommended for general cutting of masonry and concrete materials such as bricks, blocks, slate, stone and old concrete without steel bar.



TECHNICAL DATA

Item Number			Segment Thickness mm	Segment Height mm
960200514115	DW200514-4.5	115	2.4	14
960200514125	DW200514-5	125	2.4	14
960200514180	DW200514-7	180	2.6	14
960200514230	DW200514-9	230	2.8	14

Diamond Saw Blade V Shape

The range is recommended for general cutting of masonry and concrete materials such as bricks, blocks, slate, stone and old concrete without steel bar.



TECHNICAL DATA

Item Number			Segment Thickness mm	Segment Height mm
960200534115	DW200534-4.5	115	2.8	10
960200534180	DW200534-7	180	2.8	10

Diamond Saw Blade T Shape

The range is recommended for general cutting of masonry and concrete materials such as bricks, blocks, slate, stone and old concrete without steel bar.



TECHNICAL DATA

Item Number			Segment Thickness mm	Segment Height mm
960200544180	DW200544-7	180	2.8	10

Diamond Cup wheel one row

It is designed for grinding the surface of various stones such as granite, marble, engineered stone, etc along with best performance.



TECHNICAL DATA

Item Number			Segment Thickness mm	Segment Wide mm
960206110010	DW6110010	115	5	8
960206110110	DW6110110	125	5	8

Diamond Cup wheel Two rows

It is designed for grinding the surface of various stones such as granite, marble, engineered stone, etc along with best performance.



TECHNICAL DATA

Item Number			Segment Thickness mm	Segment Wide mm
960206110020	DW6110020	115	5	8
960206110120	DW6110120	125	5	8

Diamond Cup wheel Turbo

It is designed for grinding the surface of various stones such as granite, marble, engineered stone, etc along with best performance.



TECHNICAL DATA

Item Number			Segment Thickness mm	Segment Wide mm
960206110030	DW6110030	115	5	8
960206110130	DW6110130	125	5	8

TCT Circular Saw Blade For Aluminum

For Aluminum industrial user to work with it all day, long demanding precision and extended life



TECHNICAL DATA



Item Number			Cutting Width mm	Tips Number
960576020515	DW6020515	300	3.2	90

TCT Circular Saw Blade For Wood

Designed to make clean, fast, effortless cuts through wood and wood composite material



TECHNICAL DATA

Item Number			Cutting Width mm	Tips Number
960576010411	DW6010411	250	3.2	40
960576010412	DW6010412	250	3.2	60
960576010414	DW6010414	250	3.2	80

WELDING SOLID WIRE ER70S-6



TECHNICAL DATA

Item Number	SIZE	Weight
8438001160080	0.8	15kg
8438001160100	1.0	15kg
8438001160120	1.2	15kg



LOW CARBON STEEL WELDING ELECTRODES

AWS - E6013



TECHNICAL DATA

Item Number	SIZE	Current(A) AC or DC
8438001170251	2.5	70-90
8438001170320	3.3	90-140
8438001170400	4.0	140-190
8438001170500	5.0	180-240

T119B Jigsaw Blade



Applications:

Straight cutting.
Ideal for epoxy, hardwood, softwood, laminated boards, insulated and heat insulation materials, and plastics.



Wood



Plastics



Tidy cutting



HCS

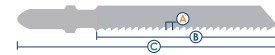

A = 2.0mm - 12tpi

B = 50mm - 2"

C = 76mm - 3"

T119BO Jigsaw Blade



Applications:

Especially for curved cutting
Ideal for epoxy, hardwood, softwood, laminated boards, insulated and heat insulation materials, and plastics.



Wood



Plastics



Tidy cutting



HCS

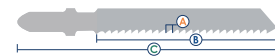

A = 2.0mm - 12tpi

B = 50mm - 2"

C = 76mm - 3"

T144D Jigsaw Blade



Applications:

Fast straight cutting
Ideal for hardwood, softwood and laminated boards.



Wood



Plastics



Tidy cutting



fast CUT



HCS



A = 4mm - 6tpi

B = 75mm - 3"

C = 100mm - 4"

T244D Jigsaw Blade



Applications:

Fast curved cutting
Ideal for hardwood, softwood
and laminated boards.



Wood



fast
CUT



Rough curve
cutting



HCS

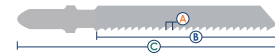

A = 4mm - 6tpi
B = 75mm - 3"
C = 100mm - 4"

T118AF Jigsaw Blade



Applications:

Bimetallic blades durable and break resistant, straight
cutting for thin plates, idea for soft metals, aluminium,
nonferrous metals, stainless metals and epoxy.

C = 100mm - 4"



Bi-
metal

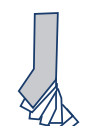

A = 1.2mm - 21tpi
B = 50mm - 2"
C = 76mm - 3"

T118A Jigsaw Blade



Applications:

Straight cutting for thin materials, Idea for thin sheet
metals, nonferrous metals, Aluminium



Tidy cutting



HSS

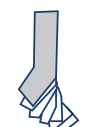

A = 1.2mm - 21tpi
B = 50mm - 2"
C = 76mm - 3"

T318A Jigsaw Blade



Applications:

Straight cutting for material with fillings, Ideal for nonferrous metals, aluminum, and for material with fillings.



Tidy cutting

HSS

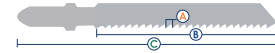

A = 1.2mm - 21tpi
B = 110mm - 41/2"
C = 132mm - 51/2"

T118GFS Jigsaw Blade



Applications:

Bimetallic blades durable and break resistant, straight cutting for thin plates, ideal for soft metals, aluminium, nonferrous metals, stainless metals and epoxy.



Bi-metal



A = 0.8mm - 32tpi
B = 50mm - 3"
C = 75mm - 3"

T227D Jigsaw Blade



Applications:

Curved cutting, ideal for nonferrous metals, aluminium, and for glass fibre reinforced plastics.



HSS



A = 3mm - 8tpi
B = 75mm - 3"
C = 100mm - 4"

S1122HF Reciprocating Saw Blade



Wood

Applications:

- 2.5mm teeth spacing
- With metal wood cutting
- Wood with nails / metal (< 175mm), metal plate, pipe aluminum profile (3-12mm), flexible flush cutting, also can be repaired by wooden pallet
- Professional quality and long life

S922BF Reciprocating Saw Blade



Applications:

- 1.8mm teeth spacing
- Metal cutting strong and tough
- Thick metal plate (3-8mm) solid pipe / profile (diameter 10-100mm) rapid cutting
- Professional quality and long life

S922AF Reciprocating Saw Blade



Applications:

- 1mm teeth spacing Metal cutting strong and tough
- Thick metal plate (0.7-3mm) solid pipe / profile (diameter 5-100mm) rapid cutting
- Professional quality and long life

S1122BF Reciprocating Saw Blade



Applications:

- 1,8mm teeth spacing
- Metal cutting strong and tough
- Thick metal plate (3-8mm), solid pipe / profile (diameter < 175mm), flexible flat cutting, fast cutting
- Professional quality and long life

S1122EF Reciprocating Saw Blade



Applications:

- 1.4mm teeth spacing
- Metal cutting strong and tough
- Thick metal plate (1.5-4mm), solid pipe / profile (diameter < 175mm), flexible and flush cutting
- Professional quality and long life

S1122AF Reciprocating Saw Blade



Applications:



- 1mm teeth spacing Metal cutting strong and tough
- Thick metal plate (0.7-3mm) solid pipe / profile (diameter 5-100mm) rapid cutting
- Professional quality and long life

SARBE SAW 10PCS SETS



Tile Scoring Wheel



<input checked="" type="checkbox"/> <input checked="" type="checkbox"/> <input checked="" type="checkbox"/> Ideal use <input checked="" type="checkbox"/> <input checked="" type="checkbox"/> Second use <input checked="" type="checkbox"/> Alternative use	 8mm 5/16"	 10mm 3/8"
RUSTIC TILES	<input checked="" type="checkbox"/> <input checked="" type="checkbox"/> <input type="checkbox"/>	<input checked="" type="checkbox"/> <input checked="" type="checkbox"/> <input type="checkbox"/>
PORCELAIN	<input checked="" type="checkbox"/> <input checked="" type="checkbox"/> <input checked="" type="checkbox"/>	<input checked="" type="checkbox"/> <input checked="" type="checkbox"/> <input checked="" type="checkbox"/>
FLOOR TILES	<input checked="" type="checkbox"/> <input checked="" type="checkbox"/> <input type="checkbox"/>	<input checked="" type="checkbox"/> <input checked="" type="checkbox"/> <input checked="" type="checkbox"/>
WALL TILES	<input checked="" type="checkbox"/> <input checked="" type="checkbox"/> <input type="checkbox"/>	<input checked="" type="checkbox"/> <input checked="" type="checkbox"/> <input checked="" type="checkbox"/>
GLASS TILES	<input checked="" type="checkbox"/> <input checked="" type="checkbox"/> <input checked="" type="checkbox"/>	<input checked="" type="checkbox"/> <input checked="" type="checkbox"/> <input checked="" type="checkbox"/>

TECHNICAL DATA

			
8117-8MM	8mm	- Pc	- Pc
8117-10MM	10mm	- Pc	- Pc

Slotted Insert Bits

TECHNICAL DATA

		Quantity
AH1010100013	SL3×25mm	20 Pcs/Box
AH1010100014	SL4×25mm	20 Pcs/Box
AH1010100015	SL5×25mm	20 Pcs/Box
AH1010100016	SL6×25mm	20 Pcs/Box



Phillip Insert Bits

TECHNICAL DATA

		Quantity
AH1020100020	PH0×25mm	20 Pcs/Box
AH1020100021	PH1×25mm	20 Pcs/Box
AH1020100022	PH2×25mm	20 Pcs/Box
AH1020100023	PH3×25mm	20 Pcs/Box

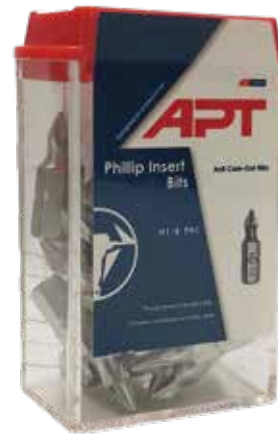

TORX Insert Bits

TECHNICAL DATA

		Quantity
AH1040100010	T10×25mm	20 Pcs/Box
AH1040100015	T15×25mm	20 Pcs/Box
AH1040100020	T20×25mm	20 Pcs/Box
AH1040100025	T25×25mm	20 Pcs/Box
AH1040100027	T27×25mm	20 Pcs/Box
AH1040100040	T40×25mm	20 Pcs/Box



Phillip Power Bits



TECHNICAL DATA

		Quantity
AH2020500020	PH0×50mm	10 Pcs/Box
AH2020500021	PH1×50mm	10 Pcs/Box
AH2020500022	PH2×50mm	10 Pcs/Box
AH2020500023	PH3×50mm	10 Pcs/Box



Phillips Double-ended Bits



TECHNICAL DATA

		Quantity
AH2021032222	PH2-PH2×65mm	10 Pcs/Box
AH2022002222	PH2-PH2×100mm	10 Pcs/Box
AH2021002121	PH1-PH1×65mm	10 Pcs/Box
AH2021002221	PH2-PH1×65mm	10 Pcs/Box
AH2021002222	PH2-PH2×65mm	10 Pcs/Box



Phillips Slotted Double Ended Bits



TECHNICAL DATA

		Quantity
AH2061002114	PH1-SL4×65mm	10 Pcs/Box
AH2061002115	PH1-SL5×65mm	10 Pcs/Box
AH2061002216	PH2-SL6×65mm	10 Pcs/Box



Torsion Phillips Impact Screwdriver bits PH2 +



TECHNICAL DATA

		Quantity
AH1020510022	PH2×75mm	10 Pcs/Box

Phillip Power impact dual use bits PH2/SL6 - +



TECHNICAL DATA

		Quantity
AH2060572216	PH2/SL6×50mm	20 Pcs/Box

Torsion Double ended Impact Screwdriver bits PH2-PH2 +



TECHNICAL DATA

		Quantity
AH2021012222	PH2-PH2×65mm	10 Pcs/Box

Torsion Double ended Impact Screwdriver bits PH2-SL5 - +



TECHNICAL DATA

		Quantity
AH2061002215	PH2-SL5×65mm	10 Pcs/Box

Phillips Slotted Double Ended Bits PH2-PZ2 - *

TECHNICAL DATA

		Quantity
AH2061002232	PH2-PZ2×65mm	10 Pcs/Box



Phillips Double ended Bits + 1pc Mag adaptor



TECHNICAL DATA

		Quantity
AH211100222	PH2x65mm	10 Pcs/Box

Stainless steel one piece construction mag bits holder 1/4-1/4

Stainless steel
Suitable for universal
1/4" (6.35 mm)



TECHNICAL DATA

	
AH4101400020	1/4"

Quick release Bit holder 1/4"

Fast Quick-release system
Heat treated
Suitable for universal
1/4" (6.35 mm)
Magnet for better bit
retension



TECHNICAL DATA

	
AH412500010	1/4" - 60mm

Quick release Bit holder set

Fast Quick-release system
Heat treated
Suitable for universal
1/4" (6.35 mm)
Magnet for better bit
retension
Three lengths: 60 mm,
1100 mm & 150 mm



TECHNICAL DATA



	
AH4132500615	60mm-100mm-150mm

Magnetic Pivot Drill Bit Holder 1/4"

Fast Quick-release system
Heat treated
Suitable for universal
1/4" (6.35 mm)
Magnet for better bit
retension
20° pivot for accessibility
in narrow and
hard-to-reach spaces



TECHNICAL DATA

	
AH4140500020	1/4" - 90mm

Flexible Drill Adapter Bit Holder 1/4"



TECHNICAL DATA

	
AH1304155-10	1/4"

Bit strong Magnetic

Suitable for universal
1/4" (6.35 mm)
Magnet for better bit retention
10 Pcs



TECHNICAL DATA

AH4180100010	

Socket Adaptor 1/4x1/2

Specially designed for manual
drive applications or with
power tools
Square tip size 3/8" (10 mm)
HEX shank size 1/4" (6.35 mm)



TECHNICAL DATA

AH130425-14	1/4x1/2

Adaptor set for socket 1/4x1/4

Specially designed for manual
drive applications or with
power tools
Square tip sizes 1/4" (6.35 mm),
3/8" (10 mm) & 1/2"
HEX shank size 1/4" (6.35 mm)



TECHNICAL DATA

AH130426-12	3/8-1/2

Quick Release 1/2" Square Drive to 1/4"

Fast Quick-release system
1/2" square female to
1/4" HEX female



TECHNICAL DATA

AH4275201412	

Angle Screwdriver Adaptor 1/4-1/4

For 90° angle operations
Reversible
1/4" (6.35 mm)
n_{max} 600 min⁻¹



TECHNICAL DATA

AH4345001414	

Check Our Range

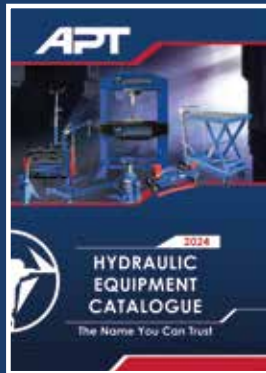
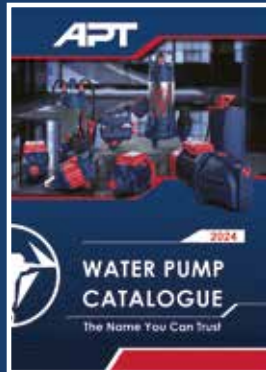

APT

The Name You Can Trust



APT

Contact Us



Info@apt-international.com

